



Ventura 150/200R - Remote Manual

Installation and Operations Manual



Spectra Watermakers
Katadyn Desalination LLC.
2220 S. McDowell Blvd Ext. Petaluma, CA 94954
Phone: 415-526-2780 Fax: 415-526-2787
info@spectrawatermakers.com
www.spectrawatermakers.com
Updated January 2024

EXCITING EXTENDED WARRANTY OFFER!

-Upgrade the standard 1-YEAR manufacturer warranty to 2-YEARS and LIFETIME on Clark Pump.

Follow the below steps to submit for approval:

- 1. Have system installed & commissioned by Spectra Authorized FSP (full-service provider)**
- 2. Fill out web-based Product Registration form (see back of owner's manual for paper copy)**
- 3. Complete web-based install/commissioning form (see back of owner's manual for paper copy)**
- 4. Upon satisfactory review of required submissions, your 4-digit system serial number will receive an extra year of warranty coverage, and lifetime coverage on the Clark Pump!**

See 'Extended Warranty' section of owner's manual for full coverage details.

Spectra Product Registration Form

(To be completed by end user/owner)



https://spectrawarranty.formstack.com/forms/product_registration

Spectra Watermakers Commissioning Report

(To be completed by authorized installer)



https://spectrawarranty.formstack.com/forms/spectra_install_commissioning_report



Note: Offer & warranty criteria effective 1/1/2021. For purchases made in the EU, please see 'Expanded Warranty' section of warranty policy in back of the manual for EU specific coverage.



Spectra Watermakers - User Manual Online Access



- Scan QR Code to Visit Spectra Manuals Page.
- Select System, then download the User Manual.
- Reference Commissioning Checklist for important installation requirements.
- Review Installation Basics section of Owner's Manual to ensure warranty compliance.

<http://katadyngroup.ladesk.com/206595-Spectra-Manuals>

Table of Contents

Installation	6
Getting Started	7
Installation Basics	8
Introduction	9
Components	10
Plumbing Layout.....	12
Ventura 150 Remote Plumbing Diagram.....	13
Product Water plumbing	14
Tube Fitting Assembly Procedures	16
Spectra High Pressure Fitting Instructions	17
Electrical	18
Wiring	19
Optional Tank Switch Wiring and Installation	21
Optional Z-Ion Installation	23
Operation	26
New Systems Start Up and Testing.....	27
Normal Operation and Fresh Water Flush	28
Dry Testing with an Artificial Ocean	29
Spectra Manual Remote Controller Guide.....	30
Adjusting Fresh Water Flush Duration	31
Maintenance, Storage, and Troubleshooting	32
Maintenance.....	33
Introduction to Spectra Chemicals	35
Ventura Remote Manual Storage Procedure.....	37
Winterizing with Propylene Glycol	38
Membrane Cleaning Procedure	39
Suggested Spares for Ventura Remote Manual.....	41
Troubleshooting.....	42
Ventura Flow Test.....	45
Nominal Operating Parameters.....	47
Poor Water Quality.....	48
Technical Bulletins	49
Ventura 150 Remote Wiring Schematic	54
Ventura 150D-200T Electrical Specifications.....	56
Exploded Views and Part Numbers	58
Owner Resources	66
Warranty, Product Registration, Installation & Commissioning Reports	67

Installation

Getting Started

Unpack the system and inspect it for damage during shipping. Freight damage must be reported to the carrier within 24 hours.

Refer to the shipping list for your system to ensure you received all of the components listed. Do not discard any packaging until you have found and identified all of the parts. The small installation parts are listed on the kit list.



WARNING

Warning! We will not be held responsible for shortages that are not reported within thirty days of the ship date.

Study the system layout diagram, component photos, and descriptions before beginning installation.

Lay out the system. Before starting the installation identify where each module and component will be placed. Ensure that there is enough clearance around the components for removal of filters and system service. Make sure you have adequate tubing and hose before starting. Additional parts may be ordered.



CAUTION

THE VENTURA 200RT IS DESIGNED FOR WARM WATER USE. OPERATION IN WATERS BELOW 50° F (10° C) MAY CAUSE HIGH OPERATING PRESSURES AND INCREASED WEAR ON THE FEED PUMP.

Ventura 150-200T Remote Manual Shipping List:

- Ventura Remote Manual kit (includes Control Box and Remote Control)
- Accumulator Assembly
- Flowmeter and Pressure Gauge Assembly
- High pressure Clark Pump with membrane pressure vessel
- Black high pressure prefilter with 5 micron filter
- Feed Pump Module Assembly with fresh water flush module
- Remote Manual install kit with black product water tubing
- Service kit
- Two lengths 5/8" Hose (25')

Installation Basics

*Thru-hull
Not Supplied.*



Important Installation Notes

- Avoid tight hose bends and excessive runs.
- Use heavy gauge wire.
- Install feed pump module as low as possible.
- Use a dedicated thru-hull with scoop type strainer.
- Do not mount components over electrical devices.

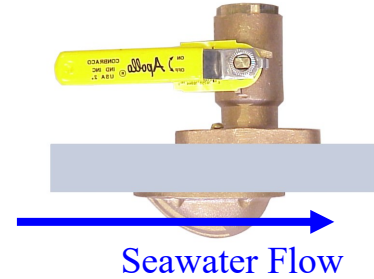

CAUTION

Avoid getting dirt or debris into the piping or hoses during assembly.

A small bit of debris can stop the system!

Thru-hull Location: The system must be connected to a dedicated 1/2" to 3/4" forward facing scoop-type intake thru-hull and seacock.

Install the thru-hull intake as far below the waterline and as close to centerline as possible to avoid contamination and air entering the system. Do not install the intake close to, or downstream of, a head discharge, behind the keel, stabilizer fins, or other underwater fixtures.

Thru-hulls in the bow area are susceptible to air intake in rough conditions. Sharing a thru-hull can introduce unforeseen problems such as intermittent flow restrictions, air bubbles, contaminants, and will void the warranty. For racing boats and high speed boats traveling above 15 knots, a retractable snorkel-type thru-hull fitting is preferred because it picks up water away from the hull.

The brine discharge thru-hull should be mounted above the waterline, along or just above the boot stripe, to minimize water lift and back pressure.

Avoid restrictions or long runs on the entire inlet side of the plumbing from the thru-hull to the feed pump module.

Secure the piping away from moving objects such as engine belts and hatches. Prevent chafe on the tubing as required. Test and inspect all piping and hose clamps after several hours of operation.

Pipe Fitting Instructions: To seal plastic-to-plastic fittings, wrap 6 to 8 layers of Teflon tape over their threads. Hold the fitting in your left hand and tightly wrap the threads clockwise. For smoother assembly, do not tape the first (starting) threads.

Wiring

- Pay attention to wire size or system performance will be impaired
- Perform wiring to UL, ABYC, CE or applicable standards

Introduction to the Ventura Remote Manual

The Ventura is the finest watermaker for small and midsize yachts. Properly installed and maintained it will provide years of reliable service. Prudent operation is required with any marine equipment.

CAUTION Always maintain enough reserve water to get safely into your next port.

The Spectra Intensifier, known as the Clark Pump, was introduced in 1997 and has been continually improved since. It is built of modern non-corrosive composites and comes with a 20" high rejection membrane.

The Clark Pump Membrane Module comes pre-mounted and plumbed together as a single unit. The combined unit saves time and adds reliability.

Front View

Brine Discharge fitting to facilitate maintenance. Can be fitted to either side of the Clark Pump**

Pressure Relief Valve

**



Double rubber mounts to absorb vibration



Fresh Water Flush Solenoid



Ventura Feed Pump Module

Includes the feed pump, cooling fan, charcoal filter, flush valve, service valve, and service port. The module has compact and streamlined plumbing. The cooling fan is included for longevity.



Note: If your system came with the optional Z-Ion, the Z-Ion unit will replace the charcoal filter housing. The photo above, and all subsequent photos of the Feed Pump Module, will look slightly different.

Components

Sea Strainer Mount close to the intake through-hull, in a location that can handle water spillage during service.



Feed Pump Module

Mount the feed pump module on a vertical surface, no more than 3-feet (1.0M) above the waterline. It is preferable to mount as low as possible. Locate in an area that allows easy access to the charcoal filter, and the service valve. Keep future maintenance in mind when choosing a location, and do not mount above water-sensitive equipment.



 **NOTE: IF INSTALLING THE Z±ION, SEE Z±ION INSTALLATION INSTRUCTIONS FOR MORE DETAILS.**

5 Micron Prefilter Bowl Locate in an area that allows easy access as this will be the most frequently serviced module while cruising. Mount vertically and leave room below bowl for filter changes.

 **CAUTION** Do not mount above water-sensitive equipment.



Components - Cont.

Remote Manual Controller

The remote control panel can be mounted anywhere dry and convenient. Cut a 5/8" (1.5 cm) wide by 5/8" (1.5 cm) high opening for the display port. The display needs minimum 2 1/2" deep clearance for the cable. Take care not to damage the plugs on the ends of the cable when routing.

Use only a Spectra-approved cable.



Note: Use only a Spectra-approved cable.

Clark Pump and Membrane

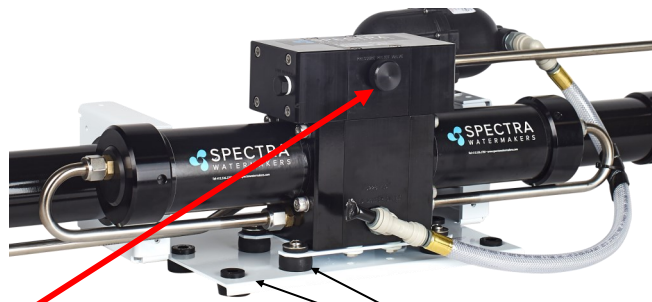

Pressure Relief Valve

Double rubber mounts
to absorb vibration

This module **must** be installed in an area that maintains a temperature below 113°F (45°C). It may be placed as high in the boat as you desire, and mounted in any position, even upside down. Make sure that the area around and under the pump does not have any water sensitive equipment, as water will be spilled during any repairs or if a leak occurs. Allow for easy access to the pressure relief valve.

The Clark pump and membrane module comes complete with a mounting system. Be sure to use the supplied washers on the rubber feet.

Ventura 150 Remote Plumbing Diagram

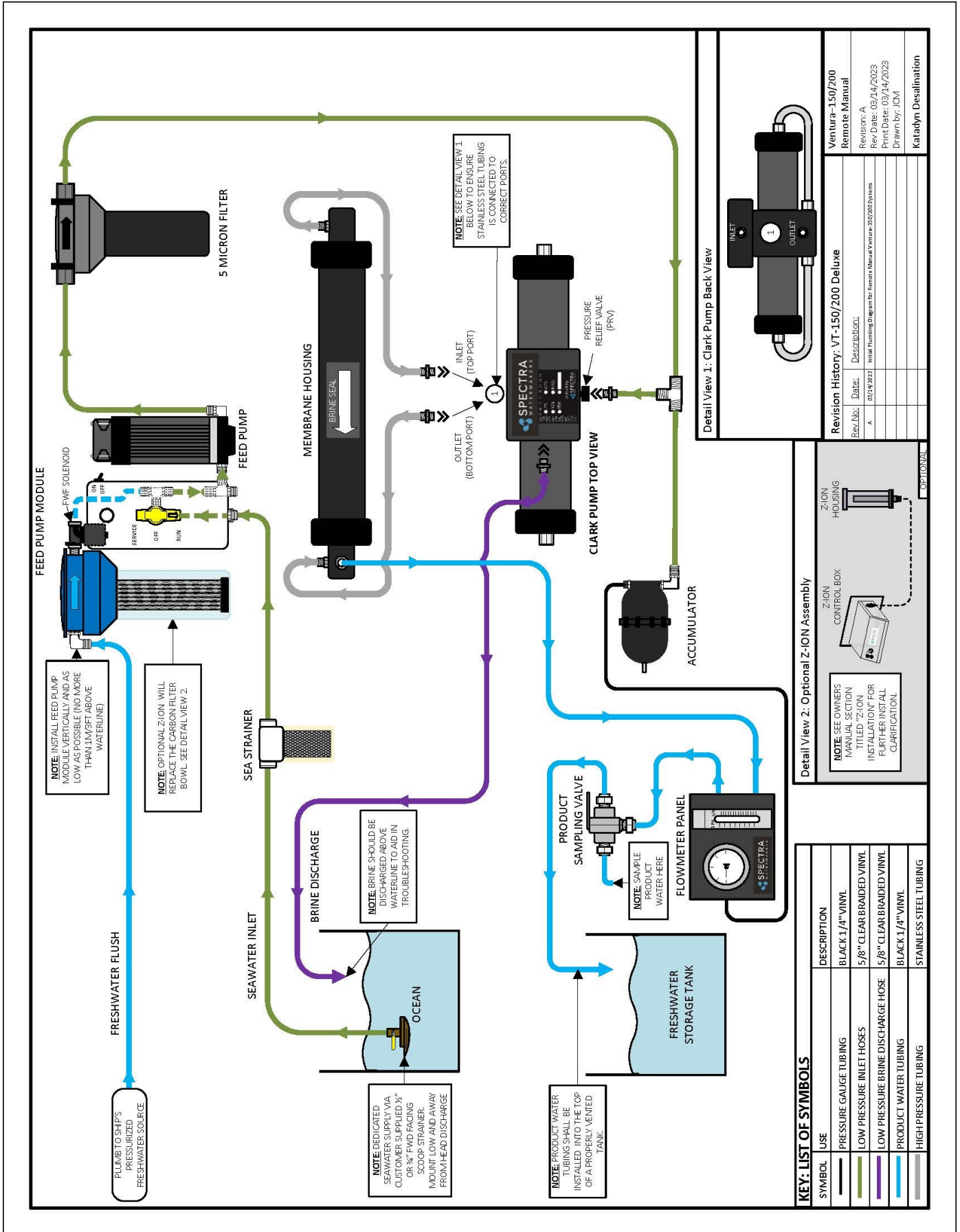

Product Water Plumbing and Pressure Gauge Tube Installation

Sampling Tap for testing the product water.

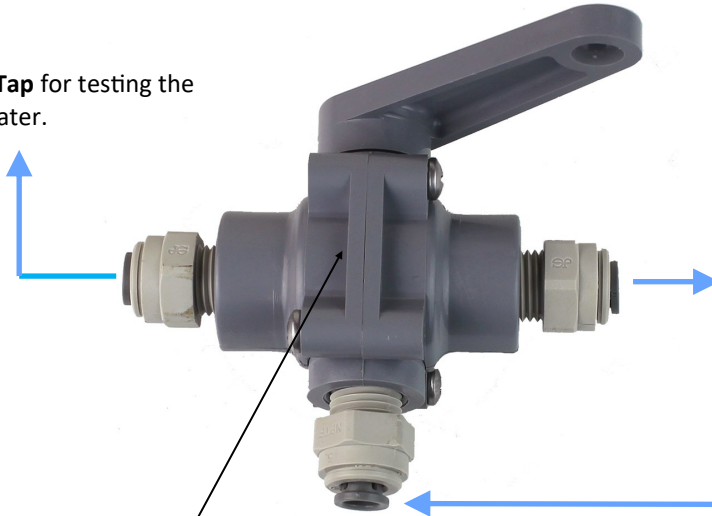

Product to tank: Route the product water from the valve into the top of a vented tank. Install a tee in the water fill or tap a pipe thread into an inspection port.

DO NOT! feed the product into a vent line, manifold, or the bottom of the tank. Make sure that there is no restriction in this piping. **Pressure in the product tubing must never exceed 5psi (.3bar)**, running or stopped, or the membrane will be permanently damaged.

Product Sampling Valve: Mount using the supplied plastic straps. **Note: the handle points in the direction of flow.**

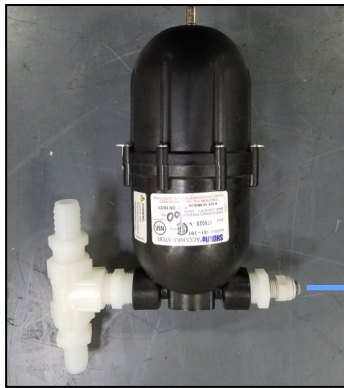

Use accumulator port to connect the pressure gauge with the supplied 1/4" black nylon tubing. Tubing must be pressure rated to 150 PSI (10 BAR).

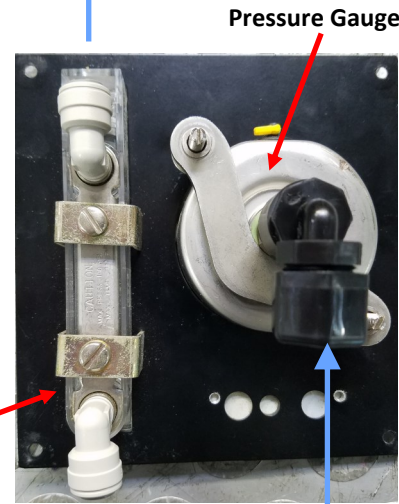

Product Flow Meter

Pressure Gauge

Back view of instrument panel

Use the supplied 1/4" black tubing for the product water plumbing.

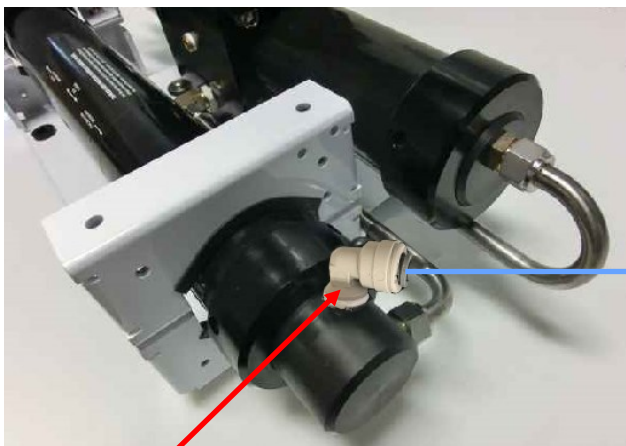

Product output fitting.

Fast & Tite® Thermoplastic Fittings

Fast & Tite® fittings are the most complete line of plastic fittings for thermoplastic tubing in the industry.

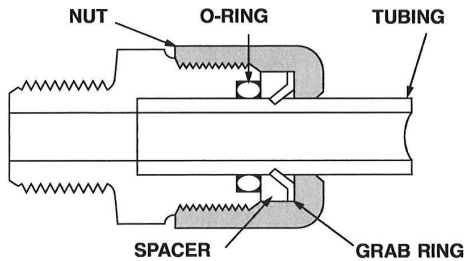

Fast & Tite® thermoplastic tube fittings from Parker will prove to be the answer to your tubing connector needs. Patented Fast & Tite® fittings install in seconds without tools and provide a tight, sure, leak proof seal without clamps or adjustments. A unique 302 stainless steel grab ring for tube retention, coupled with a Nitrile O-Ring for positive seal, assures good tube connection with only hand tight assembly. A plastic grab ring is also available upon special request. Vibration or tube movement will not break the seal and cause leakage. Preassembled in either highly inert polypropylene, or strong, durable nylon, Fast & Tite® fittings are the answer to full flow thermoplastic tubing system requirements.

When necessary, Fast & Tite® fittings can be disassembled by hand for fast system drainage. Fittings are completely reusable.

Parts are easily replaced. O-Rings are standard size and universally available. (For applications requiring other than Nitrile O-Rings, consult your Fast & Tite® distributor.)

Use Fast & Tite® fittings with Parker Parflex tubing or other plastic, glass or metal tubing for low pressure or vacuum lines up to the pressure limits shown below.

Fast & Tite® fittings meet FDA and NSF-51 requirements for food contact.

Working Pressures for Fast & Tite® Fittings

Tube O. D., in.	Air-Oil-Water Pressure in PSI		
	Up to 75°F	76° to 125°F	126° to 175°F
1/4	300	300	300
5/16	300	300	300
3/8	250	250	150
1/2	200	200	150
5/8	150	100	50

Ratings are based on use with copper tubing, and in all cases represent the maximum recommended working pressure of the fitting only. Working pressures (vs. temperatures) of other types of tubing may limit the tube and fitting assembly to pressures lower than shown above. Consult factory for recommendations on applications other than shown above.

Temperature Range:

Black/White Polypropylene: 0°F (-18°C) to +212°F (+100°C)

White Nylon: -40°F (-40°C) to +200°F (+93°C)

Fast Assembly

Step 1.

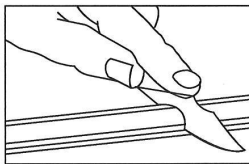

Cut the tube squarely and remove any burrs.

Step 2.

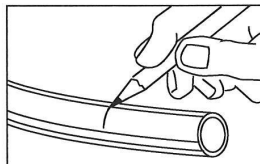

Mark from end of tube the length of insertion. (See table below)

Tube O.D. (in.)	Insertion Length with Tube Support (in.)	Insertion Length without Tube Support (in.)
1/4	5/8	9/16
5/16	5/8	9/16
3/8	13/16	3/4
1/2	7/8	13/16
5/8	1	15/16

Step 3.

Loosen nut on fitting until three threads are visible. Fittings for glass tubes must be disassembled and the grab ring removed.

Step 4.

Moisten end of the tube with water. Push the tube **Straight** into fitting until it bottoms on the fitting's shoulder. Tighten nut by hand. Additional tightening should not be necessary, but 1/4 additional turn may be added if desired. **Do not overtighten** nut as the threads will strip and the fitting will not function properly. A proper assembly will not show the insertion mark extending beyond the nut. If the insertion mark is visible, then steps 1 thru 4 must be repeated.

Step 5.

When using clear vinyl tubing or urethane tubing, it is necessary to use a **TS** tube support. Disassemble the fitting and place the nut, grab ring, spacer and tube support, in that order on the tube. Locate the grab ring at the insertion mark as shown. Seat the O-ring in the body, then proceed with Step 4.

Note: Provide adequate fail-safe mechanisms such as leakage detection sensors, automatic shut-off controls or other industry and code appropriate fail-safe devices in the design of your water-handling appliance to protect against personal injury and property damage.

Plastic fittings containing an o-ring that are used in water applications should be replaced at least every five years or more frequently depending on the environment and severity of the application.

John Guest Super Speedfit Fittings

How Super Speedfit Works

To make a connection, the tube is simply pushed in by hand; the unique patented John Guest collet locking system then holds the tube firmly in place without deforming it or restricting flow.

Materials of construction

Super Speedfit fittings are made up of three components:

Bodies are produced in an acetal copolymer or polypropylene.

'O' rings are Nitrile rubber or EPDM.

Collets are produced in acetal copolymer or polypropylene with stainless steel teeth.

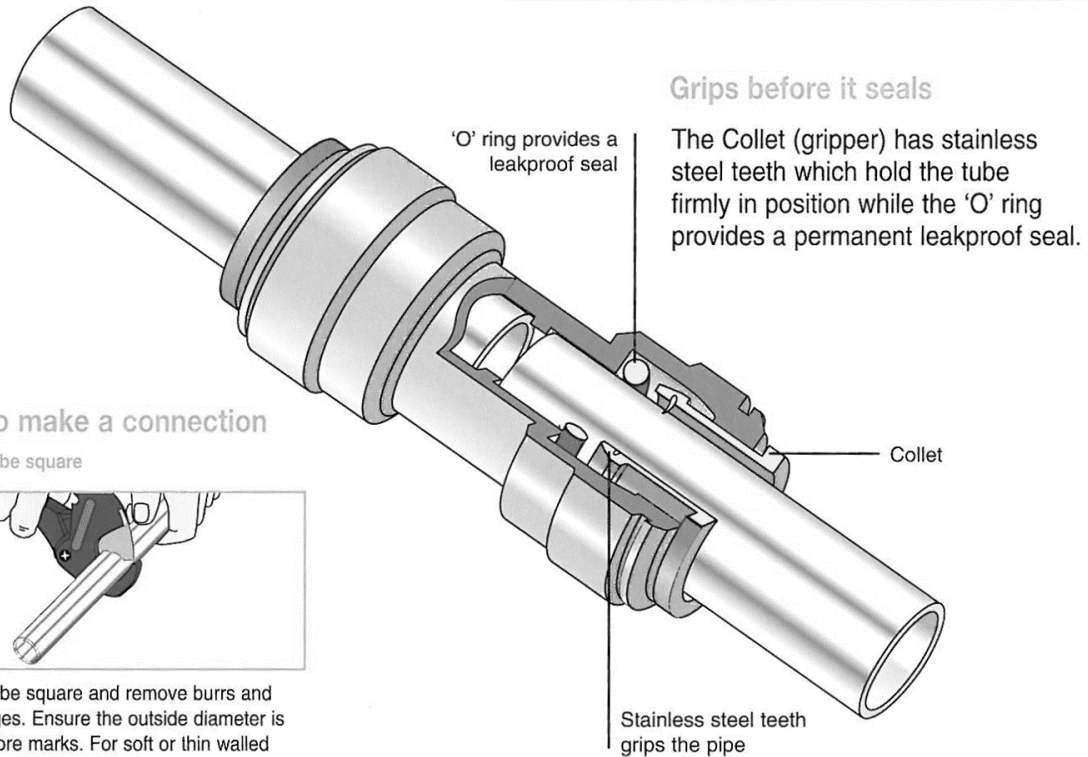

How to make a connection

Cut the tube square

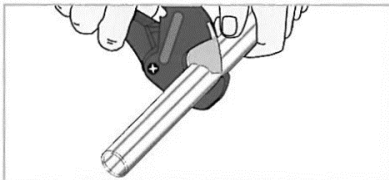

Cut the tube square and remove burrs and sharp edges. Ensure the outside diameter is free of score marks. For soft or thin walled tube we recommend the use of a tube insert

Push up to tube stop

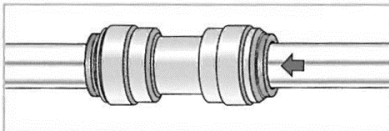

Push the tube into the fitting, to the tube stop.

Pull to check secure

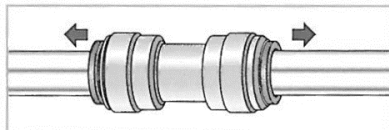

Pull on the tube to check it is secure. Test the system before use.

To disconnect

Push in collet and remove tube

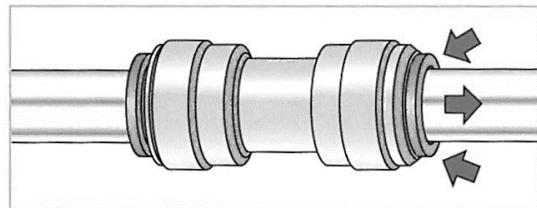

To disconnect, ensure the system is depressurized, push the collet square against the fitting. With the collet held in this position the tube can be removed.

Spectra High Pressure Fitting Instructions

The Ventura has eight high pressure fittings, two on each cylinder on the Clark Pump, two on the pressure vessel end caps, and two 90-degree elbows on the back of the Clark Pump. As the compression fitting is tightened, it compresses a ferrule onto the stainless tubing, fixing the ferrule permanently to the tube and holding the compression nut captive.

The body of the fitting seals to the underlying component with an O-ring. On the Clark Pump cylinders and the end caps this O-ring is compressed by tightening the entire fitting. The O-rings on the 90-degree fittings on the back of the Clark Pump have captive nuts and washers, which compress the O-rings without turning the entire fitting.

If a tube fitting leaks it can sometimes be resealed by just tightening. You must use two wrenches, a 13/16-inch wrench to hold the base, and a 7/8-inch wrench to turn the compression nut. The 13/16-inch wrench will need to be thin so as not to interfere with the compression nut. If this doesn't work, disassemble the fitting, grease liberally with silicone grease (the ferrule and the threads) and re-tighten firmly.

The base O-rings should be **gently** compressed to achieve a good seal, and may be damaged by overtightening.

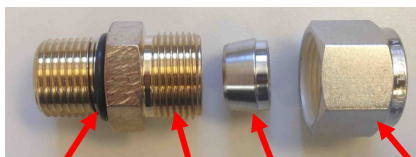

Connector O-RING

Ferrule

Stainless Fitting Hex Nut

Nickel-Bronze High Pressure Straight Fitting





Nickel-Bronze High Pressure Elbow

Electrical

Ventura Remote Manual systems are pre-fitted with waterproof connectors for electrical and signal cables. Each connector is different, so it is impossible to connect them incorrectly, and the connectors are color-coded. The system has a power inlet harness with a terminal block and cover, Pump Power cable, 2-conductor fresh water flush solenoid cable, a Z-Ion power and signal cable, and a 5-foot cable for the Remote Manual Controller.

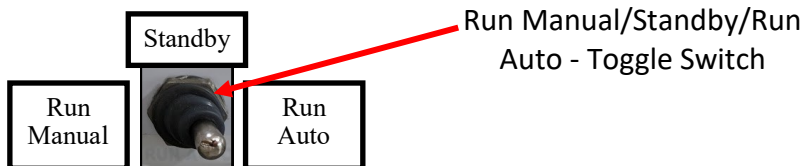
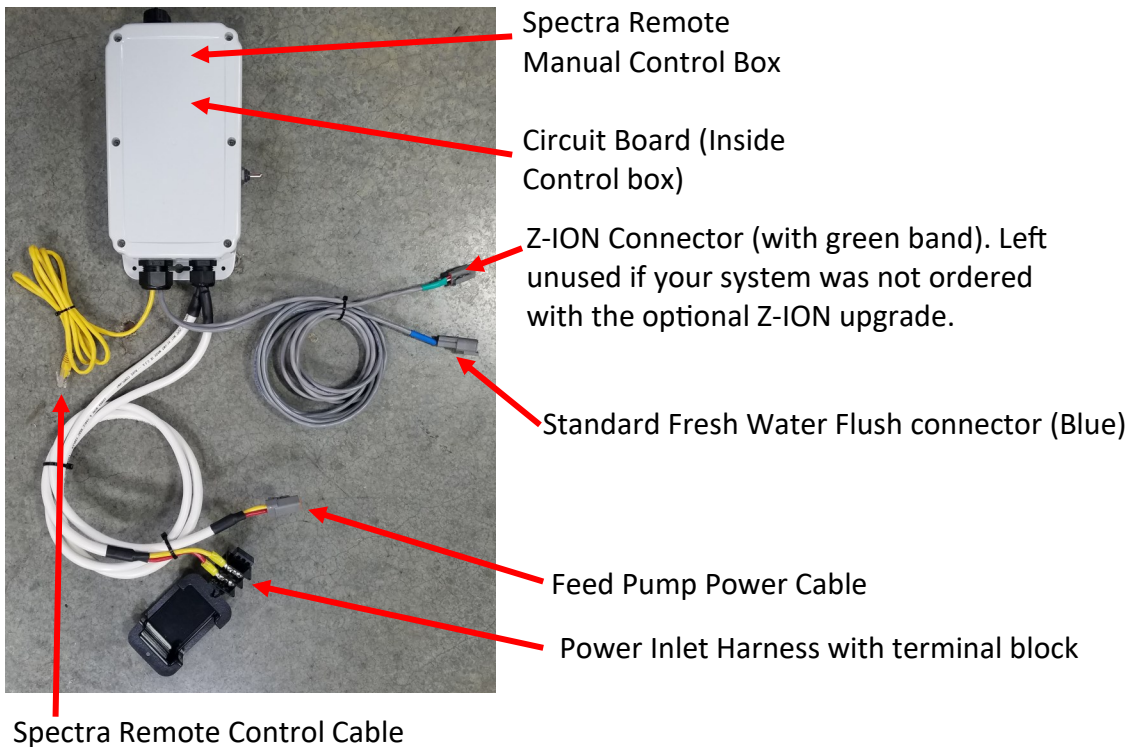
 **Do not install it in hot or poorly ventilated locations.**



 **Note:** The middle position on the toggle switch labeled “Standby” means the system is still receiving power, but the system itself is not actually running.

Electrical - Cont.

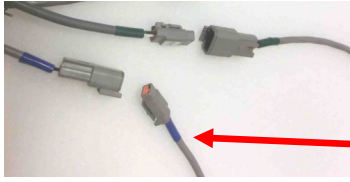

Optional Z-Ion power and signal cable (3-conductor, Green)

Fresh water flush solenoid cable (2-conductor, Blue)

The Ventura Remote Manual has one external port which is reserved for the customer to set up a local display if desired. The recommended display cable is a standard Cat 5e ethernet cable.

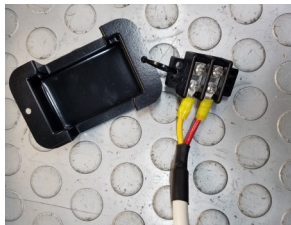

Mount the main power terminal block in a junction box or on a bulkhead adjacent to the feed pump module. Make sure that this is a dry location well above bilge level and not subject to water spray. **Be sure to install the terminal block cover.**



WARNING Do not apply voltage to the unit that exceeds 14.6 VDC. Serious damage to the electrical system may occur.

Check the wire size chart for appropriate wire sizes. DC power feeds should be uninterruptible to ensure proper operation. Avoid house breaker panels that could be accidentally tripped.

Wire Size Guide for the Ventura 12V:

Protect with 15 Amp Fuse or Circuit Breaker

10 Gauge (5mm²) up to 15 feet (4.5M)

8 Gauge (8mm²) up to 25 feet (7.5M)

6 Gauge (13mm²) up to 35 feet (10.6M)

Distances at left represent the total ROUND TRIP wire length (DC positive length plus DC negative length), NOT the length of the pair of wires together. Size cables accordingly.



Note: If the specified circuit breaker sizes are unavailable, use the next higher rating but do not exceed the specification by more than 10%. All wiring to be done to applicable ABYC, Marine UL, or CE standards.

Wiring

Important: Mount the control box with 4 appropriate fasteners on a vertical surface, above components containing water, with the wire grommets down, and central to the other system components. Make sure the cables will reach all of the modules to avoid splices. The main power feed should come from an appropriately-sized fuse or breaker on the main DC panel. See wire size and fuse/breaker tables below.



WARNING

Do not connect the main power feed until all other connections are made.

Optional Tank Switch

Customer-Supplied Tank Full Switch

Installing an optional tank full float switch at the top of your water tank allows the watermaker to fill your ship's water tank then automatically stop running. The user can then fresh water flush with by hitting 'Stop' and then 'FWF' on the Remote Controller.



Your watermaker **does not** come with the top-mounted Tank Full Switch (EL-SWT-LV). However, this part can easily be sourced from your local dealer or Full Service Provider if you wish for your system to automatically stop once your freshwater tank is full.

If you do not install the Tank Full switch in your tank, you MUST MANUALLY STOP the system when your freshwater tank has been filled. The system will not stop automatically.

Note: The float may need to be flipped 180 degrees to work properly. Many floats can be easily flipped by removing the clip opposite the wire.

Drill and tap a 1/8" NPT port into the top of the fresh water tank that is being filled by the watermaker. This can be installed on a tank access cover, or directly into the water tank. If installing on an access cover, be sure to leave a service loop on the float switch wiring to allow removal of the tank access cover.



Optional Tank Switch - Cont.

The customer supplied float switch must be connected to the **Terminals 5 & 6** labeled **Tank Full** within the Control Box that is mounted to the inside of the Feed Pump Module. There is no polarity. Remove the jumper. Connect the wires to the terminals. Use 18/2 tinned wire or larger. Wire is not included in the installation kit.

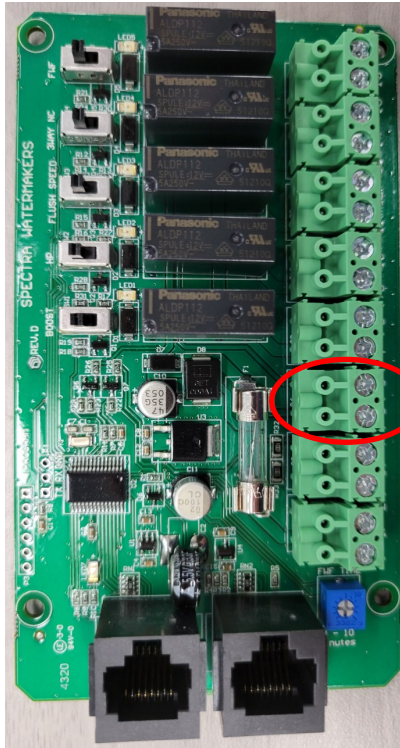

Connect to
Terminals 5 & 6



Note: Remove **only** the jumper in terminals 5 & 6.

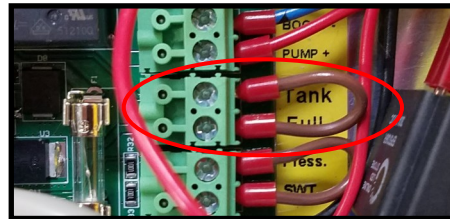

WARNING *Your watermaker should never be left running unattended.*

Watermakers should never be run unattended.



Tank Full

If a tank switch has been installed, the "Running" and "Stopped" lights will be illuminated when the tank is full and the system will stop.

Optional Z-Ion Installation

The Z-Ion replaces the fresh water flush module on the feed pump module. The Z-Ion filter bowl, like the normal fresh water flush module, houses the charcoal filter, which must be replaced every six months.

The Z-Ion control box comes with four-foot cables for flexibility in mounting on the bulkhead above or adjacent to the feed pump module.

Plug the connector from the Z-Ion generator bowl into the connector from the Z-Ion control box.

Connect the power/signal cable, marked green, from the Z-Ion control box to the Z-Ion control cable, also marked green, coming from the Remote Manual Control box.

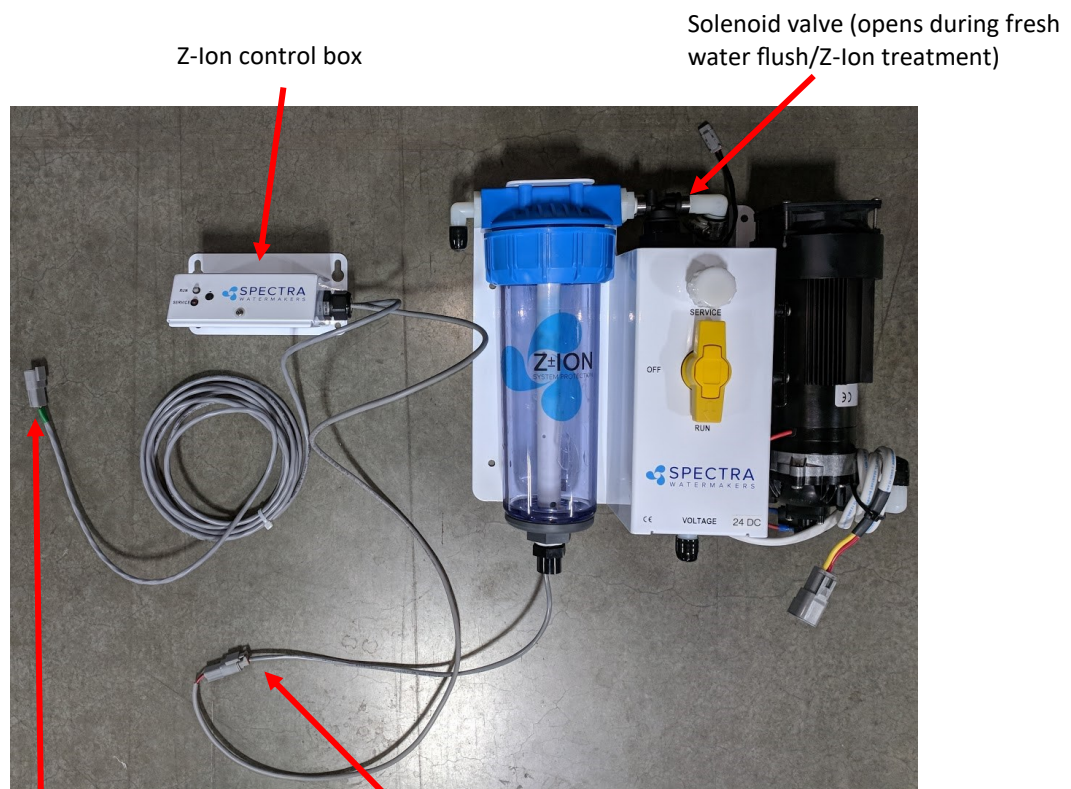

Connector to Spectra Remote Manual control box (3-pin, labeled green)

Connector to generator bowl (2-pin)

Z-Ion Operation and Installation

This revolutionary adaptation of an ancient technology effectively and safely protects the membrane and filters on your Spectra Watermaker from biological growth. Your system will be kept ready to operate without any additional flushing, external power sources, pickling chemicals, or complex procedures. The controller has been specifically designed to batch process (produce) metallic ions for system disinfection.

The process has been around for many years, however most systems produce ions on a continuous slow basis rather than a short intermittent process. We found that the most stable way to produce ions in a batch process is to maintain a constant current to the electrodes and vary the voltage. By being able to boost the voltage the amount of electrode surface area can be smaller to produce the needed ions in a brief period of time.

The Z-Ion should be energized at all times, but will only consume power when water is running through it. Upon initial power-up the LED will flash red/green and then will turn solid green.

Follow the instructions for Normal Operation and Fresh Water Flush (for treatment with the Z-Ion, the process is identical, only the Z-Ion will release silver and copper ions into the flush water.)

When fresh water flows, the operation cycle begins and the LED turn off, and only quick flashers of green and amber. The cycle will continue until either the flush cycle stops or the adjustable timer times out (factory set for 15 minutes).

If the voltage is out of range, below 10V or above 56V, the LED will flash red every two seconds and the unit will shut down.

Each fresh water flush with the Z-Ion will protect your watermaker for up to 30 days, after which the process must be repeated.

After 720 cycles the service light on the front of the control box will light up, indicating that the probes on your Z-Ion may be wearing down, and should be tested. The service light is just a reminder that your Z-Ion rods need to be inspected. Before resetting check that rods have not dissolved and are not touching.

To reset the service counter, touch two magnets, at the same time, to the two red reed switches on the Z-Ion circuit board, labeled Switch 1 and Switch 2 on the following page.

Z-Ion Layout and Specs.

Run Light
Will be green when while Z-Ion is
powered and ready



Service Light

There are 7 pins on the phoenix connector from left to right:

- Pin 1 Supply Voltage-Battery (+)
- Pin 2 Ground
- Pin 3 Trigger
- Pin 4 Auxiliary Output 1
- Pin 5 Auxiliary Output 2
- Pin 6 To ion generator (bowl). No polarity.
- Pin 7 To ion generator (bowl). No polarity.

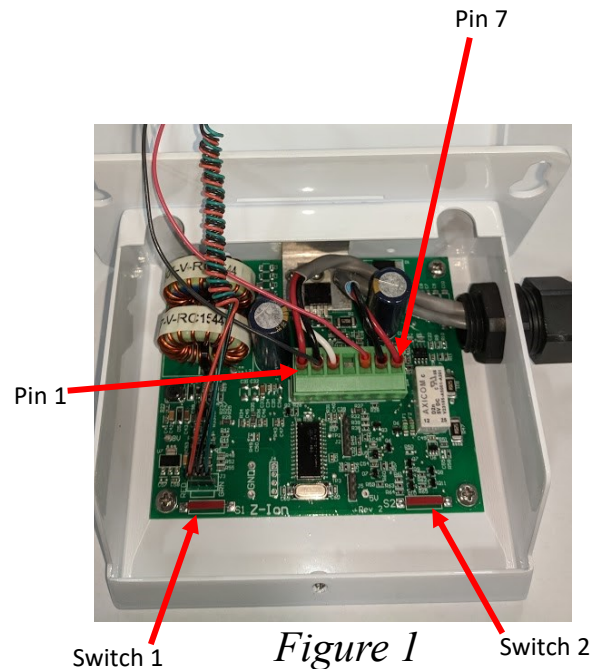

Figure 1

Auxiliary Outputs 1 and 2 are switched to the supply voltage when turned on. These outputs are protected by 100mA self resetting fuses.

Output 1 – ON during generating cycle – intended to drive a pump relay on some systems

Output 2 – ON when cycle counter reaches pre-programmed number (usually 720), when generator element may need replacement and should be tested and/or inspected.

Operation – LEDs

Power-up indication – fast red/green flash for a few seconds

Ready, Idle – solid green

Generating – the LED will quickly flash at a programmed interval (factory set to 17 seconds between flashes.)

The flash color will alternate between green and amber and will be off in between voltage spikes. The color change symbolizes the polarity alternating from positive to negative.

Bad power – fast red flash followed by shut down

High temperature – fast red flash

Cycle counter reached limit—slow red flash

Operation

New System Start-Up and Testing

Avoid running the Ventura system if the vessel is in contaminated water. The system should be fully tested before leaving port. If the location or weather prevents proper testing, refer to **Dry Testing with an Artificial Ocean** on page 29.

Every new system is shipped from the factory with nontoxic, food-grade propylene glycol. Propylene glycol, Spectra Chemicals, or anything other than seawater or freshwater must be purged from the system with the pressure relief valve open at least 1/2 turn. You can purge your system with seawater or with freshwater via the system's freshwater flush function. The system must be purged for a minimum of 60 minutes, or until at least 40 gallons of water have moved through the system.

When purging SC-1 from a pickled watermaker, system must be purged for a minimum of 20 minutes. Propylene Glycol should be purged for minimum 60 minutes

Warning! Damage may occur if the purge sequence is bypassed and the membrane is pressurized with storage chemical in it.

1. First, check that:

- Thru-hull inlet and the brine discharge valves are open.
- All of your hose connections are tight.
- The washer with the green tag under the pressure relief valve has been removed.
- The pressure relief valve is open at least 1/2 turn.
- The sampling valve is set to the sample position
- The brine line is able to freely discharge

Remove Tag and Washer!



Open 1/2 Turn when purging chemicals!



3-Way Sampling Valve



For a purge with seawater

- Move to an area free of contaminated water, such as in a polluted harbor or canal.

For a purge using the freshwater flush

- The vessel's pressurized water system is on

2. Turn on feed pump via the **manual toggle switch** and check to make sure water is coming out of the brine discharge (thru-hull above water).

3. Run the system without pressure for 60 minutes to purge the storage chemicals. The pressure gauge should read less than 35 PSI. If purging with freshwater, the sampling tube may discharge water.

4. Close the pressure relief valve. The pressure should rise to 60-80 PSI (4.2-5.7bar) on a Ventura 150 and 80-90 PSI (5.5-6.5 bar) on a 200T. Water should begin to flow out of the sampling tube. If the ship is located in brackish or fresh water, the pressure will be lower.

Depending on storage and environmental conditions the system may need to have additional purging time. If the product water does not taste pure or sample at below 500 ppm, purge or run the system for up to 6 additional hours.

Normal Operation and Fresh Water Flush

If the system has been pickled, stored, or contains cleaning compounds, use the New System Startup procedure. The system should be fully run tested before you leave port. If the location or weather prevents proper testing refer to "Testing with an Artificial Ocean."

THE VENTURA 200T IS DESIGNED FOR WARM WATER USE. OPERATION IN WATER BELOW 50 DEG F (10 DEG C) MAY CAUSE HIGH OPERATING PRESSURES AND INCREASED WEAR

1. Check that the thru-hull inlet is open.
2. Turn the product sample valve to the **SAMPLE** position.
3. Turn the yellow service valve handle on the feed pump module to **RUN**.
4. Start the system by pushing '**Start**' and check for flow by inspecting the brine discharge and checking for pressure on your analogue gauge. If there is no flow, open the pressure relief valve on the Clark Pump to prime the system and bleed the air out of the feed pump.
5. After 5 minutes, check the product water with your handheld salinity tester. When it is below 750 PPM, divert the product into your tank by rotating the product sample valve handle 90 degrees.
6. Run the system until you have filled your tank or have made enough to meet your requirements.
7. Following your water making session, perform a freshwater flush.

Freshwater Flush (You should freshwater flush your watermaker after EVERY use.)

1. Push the **Freshwater Flush** button on the remote panel.
2. The freshwater flush solenoid will open and feed pump will come on, allowing pressurized freshwater to flow through the system. Pressure will drop on the gauge, which indicates that the membrane is flooded with fresh water.
3. After a proper flush, the ppm of the brine discharge should be below 1000ppm.

You may now leave the system unattended for up to five days (30 with the Z-Ion) without further attention.

Remember that you need to run the system almost a half an hour to make enough water for a flush. You

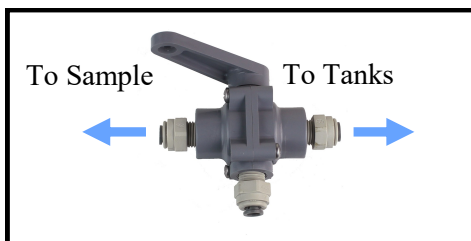

3-Way Product Sampling Valve



Analogue Gauge Panel



Remote Panel

Dry Testing with an Artificial Ocean

If it is not possible to test run the system with the boat in the water, you may test the system with an artificial ocean. You will need 1.3 lbs. of non-iodized salt (rock salt, sea salt, or aquarium salt) to make a 5 gallons (33 grams of salt per liter) of water that is about 33,000 PPM salinity (average seawater salinity). Make sure the domestic water system is powered up and the boat's tank has at least 60 gallons (230 Liters) of water to purge the storage chemicals from the system. Confirm that the charcoal filter is installed in the feed pump module, and the domestic water line is connected. If freshwater system is not available & system is still pickled, alter beginning procedure to feed unchlorinated water through the service port to purge out storage chemical.

1. **Open the pressure relief valve on the Clark Pump. Remove the green tag and spacer, if still attached.**
2. Press the **Freshwater Flush** button to run a full flush cycle. If there are storage chemicals in the system, flush for additional time to purge out chemicals. SC-1 minimum 20 minutes purge, Propylene Glycol minimum 60 minutes purge.
3. Connect the **black spiraled intake service hose**** to the service port on feed pump module, then connect the **vinyl brine discharge service hose*** to the quick disconnect fitting on Clark Pump. Refer to the photos below. Route both hoses into the 5 gallon (20 Liter) container. Turn the product sample valve to the sample position, and route the **product** into the bucket.
4. Using the remote panel, select **Freshwater Flush**. Run until the bucket is filled.
5. Turn the yellow valve to **SERVICE**.
6. Mix salt with the freshwater to the proper proportion or use an aquarium hydrometer to adjust the salinity level.
7. Push the **Start** button to run the system.
8. Allow the system to prime and then close the pressure relief valve. The system should build pressure shortly and start making water, with the brine and product water recombining in the bucket to be cycled again. This will gradually heat the water. Do not let the water temperature exceed 120 deg. F (49 deg. C).
9. Run the system under pressure, checking for proper operation and leaks. After testing the system, re-install the brine discharge hose, product tube, and freshwater hose from the strainer. You can now flush the system by pressing the **Freshwater Flush** button.



Service valve OFF, in FLUSH position



*Connecting brine discharge service hose at quick disconnect



Remote panel



**Intake service hose connected and yellow service valve handle to SERVICE



**Black spiraled reinforced intake service hose



*Vinyl Brine Discharge Service Hose

Spectra Manual Remote Controller Guide

If the system has been pickled, winterized, this is the first startup, or the condition of the system is unknown, go to NEW SYSTEM START-UP on page 27 or serious damage may occur.

A fresh water flush should be performed after every use of the watermaker. The system will need to run for approximately half an hour to make enough fresh water for one flush.



Start

Pressing the 'Start' button begins watermaker operation.



Stop

Pressing the "Stop" button ends watermaker operation. The "Stop" button must be pressed before beginning a Fresh Water Flush.



Fresh Water Flush (FWF)

Pressing the 'Fresh Water Flush' button floods the watermaker with fresh water from the vessel's domestic water tanks. Opens solenoid valve to allow water to flow from tank instead of seawater from the thru-hull. Fresh Water Flush mode will end automatically after flush is complete, approximately 3 minutes.



Fault Light

The "Fault" light indicates that there is a problem with the system, usually caused by too much or too little pressure in the feed water or membrane pressure vessel.

Adjusting Fresh Water Flush Duration

The Ventura Freshwater Flush Duration is set to a factory default of **3 minutes**, which is usually the right amount of time to ensure that sea water is thoroughly flushed out of the watermaker using the least amount of fresh water. However, due to different lengths of hose runs, different rates of flow, and different pressures in shipboard fresh water systems, the flush duration can be optimized for your boat.

Set the Flush Duration with a small screwdriver so that the fresh water flush comes to an end just as the salinity of the brine discharge drops below 1000 PPM, or no longer tastes brackish. Since the flush duration can only be adjusted in round minutes, you may want to lessen the duration to 2 minutes, to save water, or increase to 4 or more minutes to ensure a thorough flush.

Also, the charcoal filter is rated for 1.5 GPM (6 LPM): If the system pushes more than 1.5 GPM through the charcoal filter (4.5 gallons in 3 minutes), a flow regulator can be added.

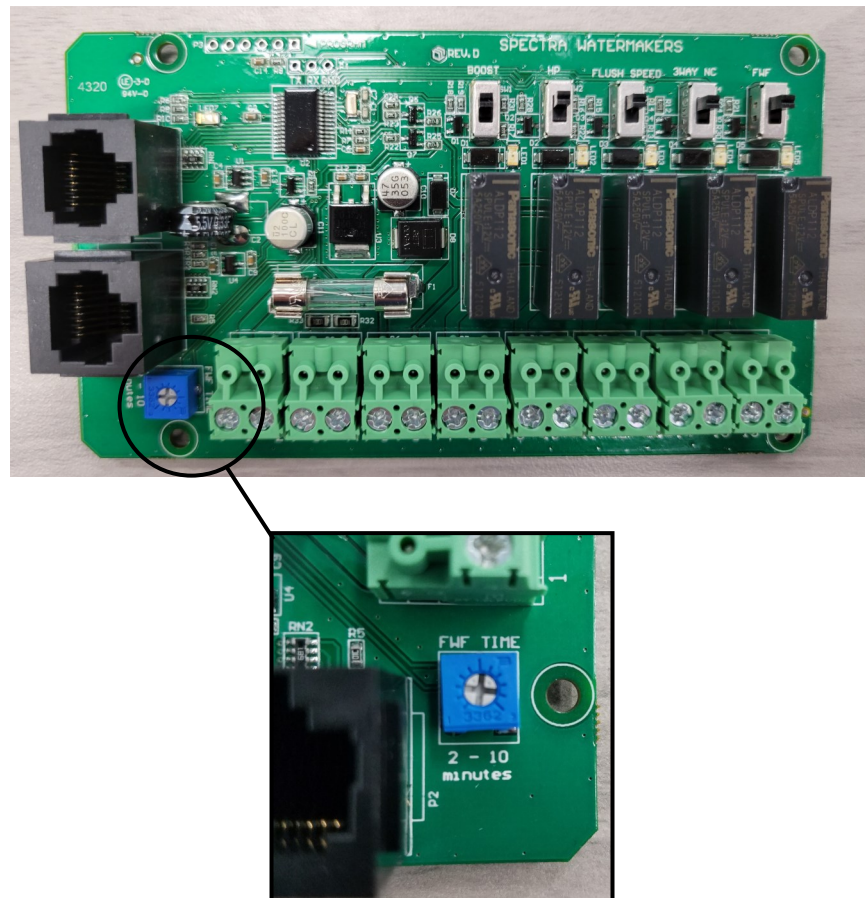

Maintenance, Storage & Troubleshoot

Maintenance



General

Periodically inspect the entire system for leakage and chafing. Repair any leaks as soon as you find them. Some crystal formation around the Clark Pump blocks is normal. Wipe down any salt encrusted areas with a damp cloth.

Watermakers are at their best when run regularly. Biological fouling in the membrane is more likely when a watermaker sits idle. A warm environment will cause more growth than a cold environment. A fresh water flush every five days (30 days with the Z-Ion) will greatly reduce biological growth, but may not stop it completely. The Z-Ion system protects the membrane from bio-fouling without the use of storage chemicals.

The Seawater Strainer

The seawater strainer's stainless steel element should be inspected, removed, and cleaned as needed. Ensure that the thru-hull is closed before disassembly and the gasket is in place before reassembly. When the system is put into storage, remove the strainer, rinse with fresh water, and reassemble dry to impede corrosion. Check frequently during operation.

The Prefilters

Prefilter elements must be changed frequently. The rate is solely dependent on the input water. A 5-micron filter might last you a 4-6 weeks in clear open ocean seawater, or be ruined in minutes in a dirty harbor. A vessel may be sailing through seemingly super clear water, but cruise through a plankton bloom and the prefilter will be ruined. Spectra does not advise to attempt to clean dirty prefilters. Prefilters are a consumable item and should be changed for new when in question.

To service the filter close the thru-hull, open the prefilter housing, remove the old filter, clean out the housing bowl, and reassemble the housing with a new 5 micron filter element. Leave dry until next startup.

Please review prefilter bulletin to page 50. prior to running your system.

Note: Use only Spectra-approved filters or you may void your warranty. Occasionally, lightly lubricate the O-rings with silicone grease.

Oil/Water Separator (Optional)

To install oil water separator capability, add a second filter housing UPSTREAM of the 5 micron housing. Service as you would per the instructions above.

Maintenance - Cont.

The Charcoal Fresh Water Flush Filter

Replace the charcoal filter element in the feed pump module **at least every 6 months**. This filter protects the membrane by removing chlorine from the flush water. Use only a Spectra-approved replacement.

The Feed Pump and Clark Pump

The feed pump and the Clark Pump require no routine maintenance except inspection for leaks. Tighten any hose clamps or fittings that show signs of leakage. The high pressure fittings threaded into the Clark Pump have O-ring seals with a straight thread. These should never leak and should never be over-tightened. If one of the tube nuts starts to leak, it can be un-threaded, sealed with a bit of silicone grease or oil, and tightened with two wrenches very tightly.

The Membrane

Membranes are susceptible to mineral scaling, biofouling and oxidation damage. The leading cause of fouling is biological growth that forms when the system is left unused without flushing or pickling. Fouling from mineral scaling can happen under certain seawater conditions, or from rust. Oxidation damage can occur if the membrane comes into contact with any strong oxidant, such as Ozone, Chlorine, etc. Monitor the product salinity and feed pressure for higher than normal readings, take environmental conditions into consideration.

Note that:

- Cold feed water or a higher salinity seawater source can cause high pressure.
- Low product flow is usually due to low voltage, a worn feed pump, or worn Clark Pump.

Due to the unique design of your Spectra system, low product water volume is typically not a membrane problem, but frequently related to low voltage, a worn feed pump head, or a worn Clark Pump. Always perform a flow test **before** cleaning your membrane.

Test to see if biological growth has occurred: Before running the system, remove the prefilter and examine its condition. If the filter housings are full of smelly, discolored water, the system was not properly stored. Install a clean prefilter.

Next check the membrane. Detach the brine discharge hose, attach the brine service hose, and lead it to a bucket. Open the pressure relief valve 1/2 turn, and manually run the system for 30 seconds (metal toggle switch on feed pump module). Examine the brine water: If it is discolored and smells bad, perform an SC-2 cleaning with unchlorinated water before running the system pressurized. If the brine is fairly clean, follow the New System Startup procedure on page 27 and run normally. Check for performance. Clean the membranes **only if** performance is reduced.

See the **Cleaning Procedure** for complete instructions.

Maintenance - Cont.

Introduction to Spectra Chemicals

We use four types of chemicals: SC-1, SC-2, SC-3, and propylene glycol antifreeze. SC-1 and propylene glycol are for system storage, while SC-2 and SC-3 are for membrane cleaning. **Do not use sodium-bisulfate, citric acid, or any other storage chemical not supplied by Spectra.** These chemicals, used to store other watermaker brands, will damage the Clark Pump, membrane end plugs, manifolds, and other components. **Using non-Spectra chemicals will void the warranty.**

****When system is unpickled, SC-1 should be purged for minimum 20 minutes. Propylene Glycol should be purged for minimum 60 minutes****

Note: Never use any chemicals with the system pressurized! Always open the pressure relief valve 1/2 turn. Always follow the instructions for purging the chemicals as shown in the New System Startup section (page 27) of your owner's manual.

Storage

SC-1 prevents biological growth when your system is idle. It should not be used as a cleaning chemical, nor will it protect your system from freezing. A jar of SC-1 is mixed with 1 to 2 gallons of product or dechlorinated fresh water in a bucket and circulated through the system for 10 minutes. This treatment will protect the system for six months, after which the SC-1 treatment must be repeated. To use SC-1, follow the instructions for **Storage Procedure**.

Spectra systems should be stored with propylene glycol if freezing is likely to occur. Propylene glycol can be used instead of Spectra SC-1 storage chemical for storage in any climate, and treatment is effective for one year. Propylene glycol is a food-grade antifreeze used to winterize RV's, boats, and cabins. Do not use ethylene glycol automotive antifreeze, which is toxic and will damage the system.

The propylene glycol formulations sold in marine and RV stores are usually diluted with water. The water remaining in the watermaker before the storage procedure will further dilute the antifreeze, reducing the microbial protection and increasing the temperature at which the mixture will freeze.

Antifreeze labeled "Minus Fifty" is a 25% solution and will begin to form an icy slush at about +15Degrees F (-10C) and will only provide burst protection to about Zero F (-18C). After a further 50% percent dilution by water remaining in the watermaker, "Minus Fifty" antifreeze will only protect from bursting down to about +25F (-4C). Therefore if low temperature freezing protection is required a 60% or stronger antifreeze should be used. 60% solutions are labeled "Minus 100" and will provide burst protection to -15F (-27C) even after a fifty percent dilution with residual water. "Minus 200" formulations are pure propylene glycol.

Maintenance - Cont.

Introduction to Spectra Chemicals - Cont.

Complete microbial protection requires a 25% solution of propylene glycol, so care must be taken that the solution remaining in the watermaker during long term storage is at least 25%, even if freeze protection is not required. For these reasons Spectra recommends that all pickling be carried out with a 60% or greater concentration.

See **Winterizing with Propylene Glycol** on Page 38.

Propylene glycol can be difficult to flush from a membrane, especially after extended storage periods. This results in high salinity water (high PPM) and residual flavor in the product water. We recommend flushing the system WITH THE PRESSURE RELIEF VALVE OPEN for 4-6 hours after storage with propylene glycol—the longer the better. If, after extended flushing, you still experience low product water quality, cleaning with SC-2 usually removes all traces of propylene glycol and returns the salinity to the level it was before storage with propylene glycol. See the **Membrane Cleaning Procedure**.

Cleaners

Avoid unnecessary cleaning, and avoid cleaning as a diagnostic tool.

SC-2 is an alkaline cleaner used to remove light oil, grime and biological growth. It is most effective if heated to 120 deg. F (49 deg. C). In most cases the water quality will increase in PPM (salinity) after an SC-2 cleaning. After a few hours it should recover to near the level it produced before the cleaning.

SC-3 is an acid cleaner used to remove mineral and scale deposits. In most cases this is used first and if there is no improvement, go on to the SC-2 cleaning. SC-3 will in most cases lower the product PPM and overall pressures. Scaling is a slow process that may take several months or years.

For cleaning with either SC-2 or SC-3, see **Membrane Cleaning Procedure**.

Ventura Remote Manual Storage Procedure

NOTE: The Ventura contains about 2 gallons of water at any given time, so with 2 gallons in the bucket there will be a total of 4 gallons of solution.

1. Close the saltwater intake seacock.
2. Push the **Freshwater Flush** button to perform a flush. **Repeat** a second flush.
3. Disconnect the brine discharge hose from the Clark Pump at quick disconnect. Replace with the **vinyl brine service hose*** from your service kit. Lead the service hose into a 5 gallon bucket.
4. Push **Freshwater Flush** again and stop the feed pump when the bucket has filled with one gallon of non-chlorinated freshwater (or fill a bucket with a gallon of distilled).
5. Mix one 8 oz. container of SC-1 storage compound with the water in the bucket. It will not dissolve completely, which is normal, and any undissolved particles will be caught by the prefilter.
6. Connect **black spiraled reinforced service hose**** to the service port (garden hose style fitting) above the yellow valve on the feed pump module and lead the hose into the solution in the bucket, creating a closed loop. Turn the yellow service valve to **SERVICE**.
7. **Ensure the pressure relief valve on the Clark pump is OPEN (unpressurized), 1/2 turn counterclockwise OR THE MEMBRANE WILL BE DAMAGED.**
8. Turn on the feed pump using **manual toggle switch*****. The system will draw solution from the bucket and return it via the brine discharge hose. Circulate the storage solution through the system for 20 minutes. Turn off the feed pump when finished.



Clean Up:

1. Remove the brine service hose from the Clark Pump brine discharge using quick disconnect, and replace with the original hose that leads to the discharge thru-hull.
2. Pump the bucket dry using the **manual toggle switch**, turn off when empty.
3. Turn the yellow service valve back to RUN. Remove the intake service hose, and replace the cap.
4. Close the seacock, drain then clean the sea strainer and prefilters. Reassemble dry with new filters. Leave the pressure relief valve open, since the next time you run the system you will need to purge the storage chemicals with the system unpressurized.

Your system is now protected from biological growth for 6 months.



Service valve OFF, in FLUSH position



*Connecting brine discharge service hose at quick disconnect



***Manual toggle switch



**Intake service hose connected and yellow service valve handle to SERVICE



**Black spiraled reinforced intake service hose



*Vinyl Brine Discharge Service Hose

Winterizing with Propylene Glycol

See description of propylene glycol formulations, and flushing from system, on page 33-34.

1. Close the saltwater intake seacock.
2. Push the **Freshwater Flush** button to perform a flush. **Repeat** a second flush.
3. Disconnect the brine discharge hose from the Clark Pump at quick disconnect. Replace with the **vinyl brine discharge service hose*** from your service kit. Lead hose into a 5 gallon bucket.
4. Push **Freshwater Flush** and stop with one gallon of freshwater in the bucket (or use distilled).
5. There are two gallons of water in the watermaker, so add potable water antifreeze to the bucket per the label instructions based on the protection level needed.
6. Connect **black spiraled intake reinforced service hose**** to the service port (garden hose style fitting) above the yellow valve on the feed pump module and lead the hose into the solution in the bucket, creating a closed loop. Turn the yellow service valve handle to **SERVICE**.
7. **Ensure the pressure relief valve on the Clark Pump is OPEN 1/2 turn (unpressurized).**
8. If a stronger concentration of antifreeze is required you can discard the first one or two gallons of water from the discharge line before placing it into the bucket to recirculate. Add more propylene glycol to the intake bucket if necessary. Turn on the feed pump using the **manual toggle switch***** and the pump will draw propylene glycol from the bucket, and the brine discharge service hose will return it, creating a closed loop. Run the feed pump and circulate the antifreeze for approximately 20 minutes. Stop the feed pump by moving the toggle switch back to 'RUN AUTO'.



Clean Up:

1. Remove the brine discharge service hose from the Clark Pump, and replace with the original brine discharge hose that leads to the thru-hull. You may now pump the bucket dry by engaging the toggle switch again. Stop when the bucket is empty, switching back to 'RUN AUTO'.
2. Turn the yellow service valve handle to **OFF**. Disconnect the intake service hose and replace cap.
3. Drain the seawater strainer and the hose leading to the feed pump module. Disconnect the product tubing from the membrane housing and blow residual water out of the tubing. Empty the charcoal filter housing and flush water lines.

Your system is now protected from biological growth and freezing for 12 months.



Service valve OFF, in FLUSH position



*Connecting brine discharge service hose at quick disconnect



***Manual toggle switch



**Intake service hose connected and yellow service valve handle to SERVICE



**Black spiraled reinforced intake service hose



*Vinyl Brine Discharge Service Hose

Membrane Cleaning Procedures

Spectra cleaning compound (SC-2 or SC-3) must be mixed with freshwater at a ratio of 1 container of compound to 3 gallons (12L) of non-chlorinated water. An average of two gallons (8L) of water is already present inside a Ventura system, so this water must be figured into the mixture. A Ventura system requires one container of compound per cleaning.

1. Turn the yellow service valve on the feed pump module to **OFF** (horizontal, see photo*).
2. Push **Freshwater Flush** to flush the system. **Repeat**, to flush the system twice.
3. Remove the cap on the service port on the feed pump module and install the **black spiraled reinforced intake service hose**** from the service kit. Remove the quick disconnect fitting from the brine discharge outlet of the Clark Pump, and replace it with the **vinyl brine discharge service hose*****. Lead both hoses into a 5 gallon (20 liter) bucket.
4. Push the **Freshwater Flush** button and run the feed pump until one gallon of fresh water runs into the bucket from the brine discharge service hose (or fill with a gallon of distilled water). Stop the system.
5. Turn the yellow service valve to the **SERVICE** position.
6. **Make sure that the pressure relief valve on the Clark Pump is open (unpressurized).**
7. Mix the SC-2 or SC-3 cleaning chemical in the bucket with the freshwater. If possible (for maximum effectiveness), heat the solution to approximately 120 deg. F (49 deg. C).
8. Start the system using the **manual toggle switch****** on the control box. The intake service hose will draw solution from the bucket and the brine discharge service hose will return it. Circulate the solution through the system in this manner for 45 minutes.
9. Stop the pump. Replace the brine discharge overboard hose and run the pump until the bucket is empty. Stop the pump and turn the yellow service valve back to the RUN position. Restart the pump and run for 20 minutes to flush the chemicals out of the system (**DO NOT CLOSE the pressure relief valve!**)
10. Move the manual toggle switch on the Control Box to RUN AUTO.

The system may now be restarted, flushed, or stored.



*Service valve OFF, in FLUSH position



***Connecting brine discharge service hose at quick disconnect



****Manual toggle switch



**Intake service hose connected and yellow service valve handle to SERVICE



**Black spiraled reinforced intake service hose



***Vinyl Brine Discharge Service Hose

Service Mode - Example



Figure 2

Illustrates hose connections and subassemblies for winterizing, storage procedures, and membrane cleaning.

Suggested Spares for Ventura Remote Manual

Short term cruising, weekends etc.

Two treatments worth of preservative chemicals (either 2 bags of SC-1 or 2 gallons of Propylene Glycol). Six 5-micron filters and a charcoal filter.

Cruising 2 to 6 months at a time.

Four treatments worth of preservative chemicals (either 4 bags of SC-1 or 4 gallons of Propylene Glycol). Twelve 5-micron filters and two charcoal filters.

Longer than 6 months

Additional filters, offshore cruising kit consisting of Clark Pump seals, O-rings, tools and membrane cleaning chemicals are recommended. One replacement strainer screen, replacement O-ring for strainer screen, and replacement O-rings for the filter housings. Spare feed pump or feed pump diaphragm.

Common Parts:

Item	Part Number
SC-1 STORAGE CHEMICAL	KIT-CHEM-SC1
SC-2 CLEANER	KIT-CHEM-SC2
SC-3 CLEANER	KIT-CHEM-SC3
BASIC CRUISE A	KIT-BCK-A
OFFSHORE REBUILD KIT	KIT-OFFSH
5 MICRON FILTER	FT-FTC-5
CHARCOAL FILTER	FT-FTC-CC
5" STRAINER SCREEN	FT-STN-5S
OIL/WATER FILTER	FT-FTC-OW
FEED PUMP	EL-FP-12V
FEED PUMP HEAD	PL-PMP-SFPH
FEED PUMP DIAPHRAGM	EL-FP-DP
5" STRAINER O-RING	SO-STN-5SS
FILTER HOUSING O-RING	SO-FHS-10H
SALINITY PROBE	EL-MPC-SP4
CHARCOAL FILTER HOUSING O-RING	SO-FHS-3PCS10

Troubleshooting Ventura Remote Manual Systems

SYMPTOMS	PROBABLE CAUSE	REMEDY
No product flow, good brine discharge flow, Recovery percentage is 0 (See Flow Test)	<ul style="list-style-type: none"> Internal leak in Clark Pump 	<ul style="list-style-type: none"> While system is running, kink brine hose to stop flow until pressure rises to 125psi, release hose quickly, repeat no more than 10 times in succession Inspect Clark Pump Check Valves Complete Service is recommended. Contact Dealer or see Clark Pump re-build manual. Install Offshore Kit
Feed pump runs with loud noise	<ul style="list-style-type: none"> Intake blocked Air in system 	<ul style="list-style-type: none"> Check thru-hull valve Check sea strainer for leaks Check fresh water flush module for leaks Re-prime system (restart)
Pump runs intermittently, cycling on/off	<ul style="list-style-type: none"> Overpressure switch on ShurFlo pump opening 	<ul style="list-style-type: none"> Adjust or replace switch (see page 58)
Feed Pump not running, no noise	<ul style="list-style-type: none"> No power at feed pump Pressure switch Failed 	<ul style="list-style-type: none"> Check voltage at pump Adjust or bypass. To bypass, jump terminals on switch with electrical wire. Only bypass to test, not run long term.
Feed pump turns on, no pressure	<ul style="list-style-type: none"> Feed pump air locked Pressure relief valve open 	<ul style="list-style-type: none"> Open pressure relief valve to bleed the air, then close to start Close pressure relief valve
Display activates, but pump will not run	<ul style="list-style-type: none"> Loose or broken pump wire connection Tanks are full (if equipped with tank switch). If full, Run & Stop LED should be lit. 	<ul style="list-style-type: none"> Check wiring at terminal block inside control box Check tanks– system cannot be started if tanks are full.
System runs, no product water delivered to water tanks	<ul style="list-style-type: none"> Disconnected or broken product tubing 3-Way Valve Incorrectly set 	<ul style="list-style-type: none"> Check product tubing Check 3-Way Valve position
Low Feed Pressure, Low Amperage	<ul style="list-style-type: none"> Warm saltwater or brackish water 	<ul style="list-style-type: none"> Normal condition
High feed pressure, High Amperage, & Product Flow down up to 15%	<ul style="list-style-type: none"> Colder or more saline water Brine or product flow path subject to back pressure Scaled or fouled membrane 	<ul style="list-style-type: none"> Normal condition Confirm by routing into a bucket to test Clean Membrane

Troubleshooting Ventura Remote Manual Systems

SYMPTOMS	PROBABLE CAUSE	REMEDY
Low product flow, more than 1 GPH Total flow down (see flow test)	<ul style="list-style-type: none"> • Motor receiving less than 12.5 VDC • Blockage or restriction in system • Thru-hull blockage • Mineral Scaling • Pump or Motor worn 	<ul style="list-style-type: none"> • Check wiring for voltage drop. Increase wire size if necessary • Check power supply • If available, turn on battery chargers • Replace prefilter, service strainer, check all hose runs • Confirm by using intake service hose and bucket of seawater to bypass. • Clean Thru-hull • Perform SC-3 Cleaning (<i>Note: By design, it is rare for a membrane to cause low total flow on Spectra systems</i>) • Pump should be able to reach 125psi within 3 seconds, & push 1.6 G/M • Replace pump head
Low product flow. Recovery percentage below minimum nominal value (See Flow Test)	<ul style="list-style-type: none"> • Pressure relief Valve open partially • Internal leak in Clark Pump 	<ul style="list-style-type: none"> • Close Pressure relief valve • Complete service recommended. Contact dealer of see Clark Pump rebuild manual. • Install offshore kit
Asymmetrical pressure and flow readings between pump shifts, more than a few psi	<ul style="list-style-type: none"> • Scored Clark Pump annular rings and/or reversing valve spool • Scored Clark Pump piston rod and/or lip seals • Scored Clark Pump cylinders 	<ul style="list-style-type: none"> • Replace • Confirm by opening test port on back of Clark Pump. If constant flow, replace seals and circular sand rod (240 grit) or replace piston rod • Hone, circular sand (240 grit) or replace

Troubleshooting Ventura Remote Manual Systems

SYMPTOMS	PROBABLE CAUSE	REMEDY
PPM High	<ul style="list-style-type: none"> • TDS meter needs calibration • Feed Flow or Clark Pump Problem • Membrane fouled or damaged • Fouled Prefilters 	<ul style="list-style-type: none"> • Recalibrate TDS meter or taste test water until it can be replaced • Low product flow, recovery percentage, or feed pressure can lead to drop in product water quality. Perform Flow Test & address flow issue. • Clean membrane or consult dealer about membrane damage. <ul style="list-style-type: none"> * <i>If system flow (product plus brine) is to specification, the membrane is clean, the product flows are consistent with the system flow, and the water quality is still not acceptable, then replacement of the membrane is indicated. By design, high ppm typically has to do with something other than the membrane itself.</i> • Freshwater flush procedure needs to be tested and adjusted. PPM of brine discharge must be below 1000ppm at end of flush cycle. • Replace filters or run watermaker for an extended period of time with pressure relief valve open to rinse.

Ventura Flow Test

The flow test is the most useful diagnostic test for system performance, and should be done before replacing or cleaning your membrane. Changes in production or water quality are normally caused by something **other than** the membrane, unless the system has been left unused for a long period of time.

Before the flow test, change all filters and clean the sea strainer. Carefully check for water or air leaks, as air in the system will cause low production and erratic salinity. Look for air bubbles in the product flow meter, feed water hoses, and brine overboard hose.

Run the system and watch the feed pressure very closely. If the feed pressure to the Clark Pump is asymmetrical from one stroke to another, this could be part of the problem. **A difference of a few PSI is acceptable, but anything over that is an issue.** If the pump is asymmetrical, Clark Pump repairs should be done before continuing with these tests.

If no asymmetry is noted, continue with this test.

Make sure the ShurFlo overpressure cutout switch (PL-PMP-SFPH) is set to 125 PSI. With the pump running, close the brine discharge thru-hull or kink the brine discharge hose. The feed pressure should rise to 125 PSI, then the pump should shut off. If the pump shuts off at a lower pressure see Adjust ShurFlo Pressure Switch on page 53.

You will need a graduated bucket, either a graduated pitcher or large measuring cup, and a stopwatch. Before the flow test, change all filters and clean the sea strainer. Log the voltage at the feed pump at the same time. Confirm at least 12.5 Volts at the feed pump on 12-Volt DC systems; 25 volts on 24-Volt DC systems.

Take two measurements and compare them with the table on the following page. The first measurement is the product flow alone. The second is the product flow combined with the brine discharge flow to get the **total flow or feed flow**. You may take these measurements by two methods:

1. Time the product flow into a graduated pitcher, then divert both the product flow and brine discharge together into a bucket to measure total flow.

OR

2. Divert the product flow into the pitcher while diverting the brine discharge into the bucket. Time the flow of both. After calculating the product flow, pour the pitcher of product into the bucket of brine to measure total flow.

The ratio of product flow to total flow gives us our recovery rate, as a percentage. If the percentage is below the minimum it indicates an internal leak in the Clark Pump.

Ventura Flow Test - Cont.

1. Product Flow: Product flow is expressed in Gallons Per Hour (GPH) or Liters Per Hour (LPH), by this equation:

$3600 \div \text{time in seconds} \times \text{quantity of water in gallons or liters} = \text{GPH or LPH}$
 There are 3600 seconds in an hour.

Example: It took 3 minutes and 35 seconds to collect 1 gallon of product water.

$3600 \div 215 \times 1 = \mathbf{16.74 \text{ GPH}}$ (3 minutes, 35 seconds is 215 seconds)

Example: It took 2 minutes and 25 seconds to collect 2.5 liters of product water.

$3600 \div 145 \times 2.5 = \mathbf{62.07 \text{ LPH}}$ (2 minutes, 25 seconds is 145 seconds)

2. Total Flow or Feed Flow: Feed flow or total flow (brine + product) is expressed in Gallons Per Minute (GPM) or Liters Per Minute (LPM), by this equation:

$60 \div \text{time in seconds} \times \text{quantity of water in gallons or liters} = \text{GPM or LPM}$

Example: It took 1 minute and thirty-seven seconds to collect 5 gallons of total flow.

$60 \div 97 \times 5 = \mathbf{3.09 \text{ GPM}}$ (1 minute, 37 seconds is 97 seconds)

Example: It took 53 seconds to collect 12 liters of total flow.

$60 \div 53 \times 12 = \mathbf{13.58 \text{ LPM}}$

3. Recovery Rate: Product Flow \div Total Flow = Recovery Rate %

Example: $\frac{6.5 \text{ GPH product flow}}{1.7 \text{ GPM total flow} \times 60} = \mathbf{.063 \text{ or } 6.3\%}$

(you must first multiply total flow by 60 to convert from GPM to GPH)

System	Feed		Static *	Feed Flow				Product Flow			
	Pressure		Pressure	Flow		MIN	MIN	Flow	Flow	MIN	MIN
	psi	bar	psi	gpm	lpm	gpm	lpm	gph	lph	gph	lph
Ventura	60-70	4.2-5	10-15	1.7	6.4	1.65	6.2	6.5	24.6	5.7	21.5
VT 200	80-90	5.6-6.3	20-25	1.7	6.4	1.6	6.0	8.3	31.4	7.7	29.1

For Spec Production:

12V Systems: Run at 13.2 VDC min

24V Systems run at 26.4 VDC min

***pressure relief valve open ½ turn**

In order to make good quality product water, you need the proper amount of feed water flow, as in the table above. Compare the product flow to the total feed flow. Product flow should be 6.5% minimum 5.5%) of total flow for a Ventura 150, and 9% (minimum 8%) of total flow for a Ventura 200T. If product percentage is low, you may have an internal leak in the Clark Pump.

For every $\frac{1}{10}$ th of a GPM feed water flow loss, we will lose about $\frac{1}{2}$ gallon per hour of product flow and the salinity will go up 100 PPM.

46 Low feed flow combined with low system pressures is most frequently caused by a worn Shurflo pump head (PL-PMP-SFPH).

Nominal Operating Parameters

Parameter	Minimum	Maximum
Product Quantity	5.7 GPH (21.5 LPH)/Ventura 150 7.7 GPH (29.1 LPH)/Ventura200	6.5 GPH (24.6 LPH)/Ventura 150 8.3 GPH (31.4 LPH)/Ventura 200
Product Quality	<300 ppm	750 ppm
Feed Pressure	N/A	70 psi (5 bar)/Ventura 150 90 psi (6.3 bar)/Ventura 200
Amp Draw Ventura 150	9.0A @ 14VDC; 4.5A @ 26VDC	
Amp Draw Ventura 200	10.0A @ 14VDC; 5A @ 26VDC	
Total Flow (Brine + Product)	1.65 GPM (6.2 LPM)	

Poor Product Water Quality

With any product water quality issue, you must ensure accurate calibration if you are using a salinity meter. For general quality evaluation, your taste is always good enough.

Using membranes for water desalination through reverse osmosis is not an exact science and two identical systems can have different product quality. World health standards deem water of up to 1000 PPM of total dissolved solids acceptable for drinking. We consider anything below 750 PPM acceptable but not ideal, and anything below 500 PPM excellent. Factors that could affect water quality are addressed below.

LOW SYSTEM FLOW OR PRESSURE will equate to lower product quality (higher PPM).

Ventura systems, which have a higher feed to output pressure ratio (See nominal pressures under Flow Test, page 45), as well as a higher feed flow/membrane area ratio, will produce water in the 150-200 PPM range.

DAMAGE TO THE MEMBRANE by chlorine contamination. Flushing the system with chlorinated water will irreparably damage the membrane. Charcoal filters are used to absorb any chlorine which might be present in flush water. They must be of proper specification to be suitable. There is no test for chlorine damage except the process of elimination of other causes.

DIRTY OR SCALED membranes. A dirty (foreign material), scaled (mineral deposits), or contaminated (bacterial growth) membrane can result in poor water quality and abnormal operating pressures. If operating pressures are above normal, then cleaning is indicated. If the system pressures are within operating normal range, cleaning may have little result. Avoid cleaning as a diagnostic tool. Low water quality after storage with propylene glycol can usually be remedied by extended flushing or an SC-2 cleaning. (See pages 44-45 and 48.)

MECHANICAL LEAKAGE within the membrane pressure vessel. This is an unlikely but possible cause of poor water quality. A pinched or damaged O-ring within the pressure vessel, a scratch on the product tube on the membrane, a scratch within one of the end caps, or a seal fouled by contamination could allow sea water into the product water.

If system flow (product plus brine) is 1.5 GPM or above, the membrane is clean, the product flows are consistent with the system flow and the water quality is still not acceptable, then replacement of the membrane is indicated.

Technical Bulletins

The following pages include Spectra's most commonly-used technical bulletins, covering tests, adjustments, troubleshooting, and common points of confusion. Many more technical bulletins are available on the Spectra website, support.katadyngroup.com.

ACCUMULATOR PRESSURE

Your Spectra watermaker is supplied with a pressure accumulator tank (PL-ACC-TK), which should be installed in the feed water line between the 5 micron Prefilter and the Clark Pump.

The purpose of the feed line accumulator is to reduce the spikes in the feed pressure caused by the cycling of the Clark Pump. If the accumulator is not properly charged it can lead to problems with the Shurflo Pump pressure cutout switch. The accumulator has a Schrader air valve, like a car tire, which allows the internal air bladder of the accumulator to be pre-charged. The accumulator should be pumped up to about 65 psi (4.5 bar) for best results. Add air using a tire pump or air compressor. You can experiment with the exact pressure that will give the best pulsation dampening on your installation.

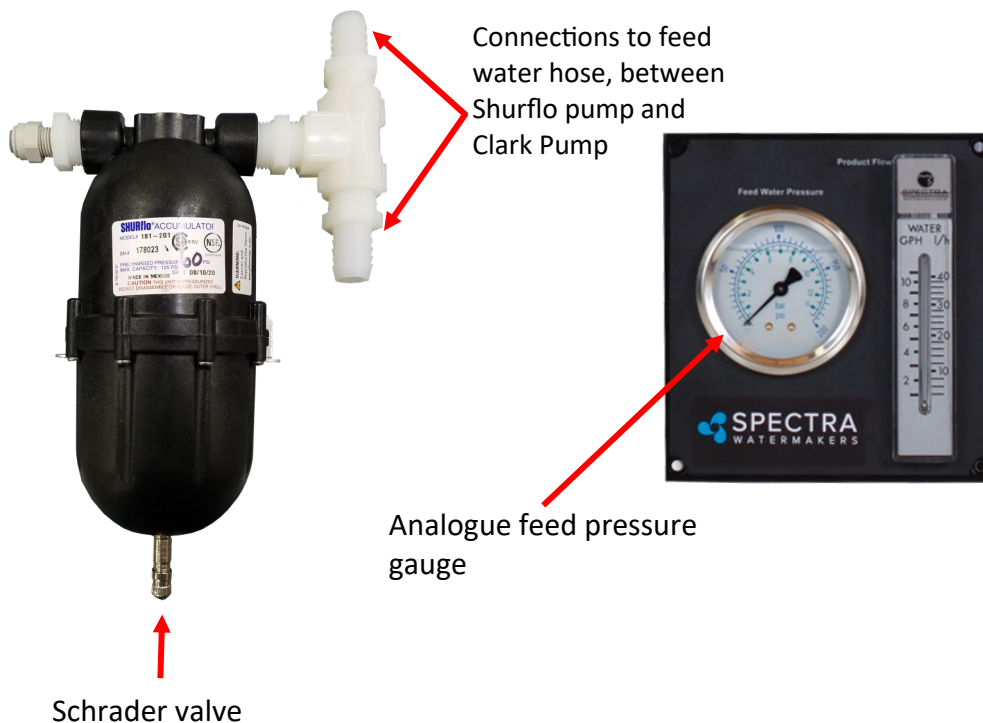

PREFILTERS

It is important to remember that your Spectra Watermaker is designed to process clean, open-ocean seawater. Any departure from that standard for your seawater intake runs the risk of causing excessive wear or damage to internal pump parts and/or the vulnerable reverse osmosis membrane. Additional prefiltration considerations and/or extremely frequent prefilter replacements may be required in any deviation from open-ocean seawater. Your local service provider or installer may have specific recommendations based on their experience with water conditions unique to your region.

Observe the seawater around your vessel. Is it clean enough to use for your seawater intake? There are several things to avoid feeding to your watermaker:

- *petroleum products, such as oil, fuel, thinners, paints, paint removers, etc.*
- *chlorine-treated water; e.g., most “dock” water*
- *silty water — water contaminated by fine, hard, suspended particulates*
- *putrid water, “red tides”, or any seawater that smells or looks contaminated*
- *harbor/marina water that you cannot see through or that shows visible signs of contaminate (neighboring boats docked nearby may be discharging contamination! Sewage, chemicals, etc.)*

Judging the quality of seawater input always involves a certain calculated risk. We know of watermaker systems that have been destroyed far offshore by intaking fresh whale excrement or oil contaminants from natural seepages. The chance of such things happening is normally small but should be considered. On the other hand, **regularly running a watermaker in an enclosed marina or harbor runs a much higher risk of harmful contamination.** If you need to test a new installation while in a marina or harbor, monitor the water quality around your vessel carefully while testing. Often times you should be able to run the watermaker safely for enough time to briefly check out the system if you are mindful of external feed conditions. If this is not possible, an artificial ocean is a useful alternative (see Page 29 for artificial ocean testing/instructions). Don't sail away without testing a new installation or repair!

During normal operation, the feed water is filtered in two stages. First it passes through a fine mesh metal sea strainer, which protects the feed pump from foreign materials and sea creatures. After passing through the feed pump, the feed water passes the filter housings containing 20 and 5 micron elements, removing very fine particles that could damage the Clark Pump and shorten membrane life. An additional carbon filter prevents the entrance of chlorine during fresh water flushing (see next page).

Prefilter maintenance schedules will vary widely depending on how and where the system is used. If large amounts of feed water are run through the system over a relatively short period of time in biologically fertile near-shore waters, the prefilters will plug up, water production and quality will drop, and the system pressure will change dramatically. In blue water conditions the prefilters may only need to be changed every week or two.

When operated for only an hour or two a day in inland or near-shore waters, the trapped plankton will begin to decay in the filters long before the elements plug up. The decaying plankton and bacteria will cause a rotten egg smell in the product water. This decay will set in overnight in tropical waters, or after a week or two in higher latitudes

PREFILTERS CONT.

Our filter element part numbers are FT-FTC-XX, where the last digits indicate the micron rating. FT-FTC-5 is for a 5 micron element, FT-FTC-20 is a 20 micron element. The optional oil/water separator is FT-FTC-OW.

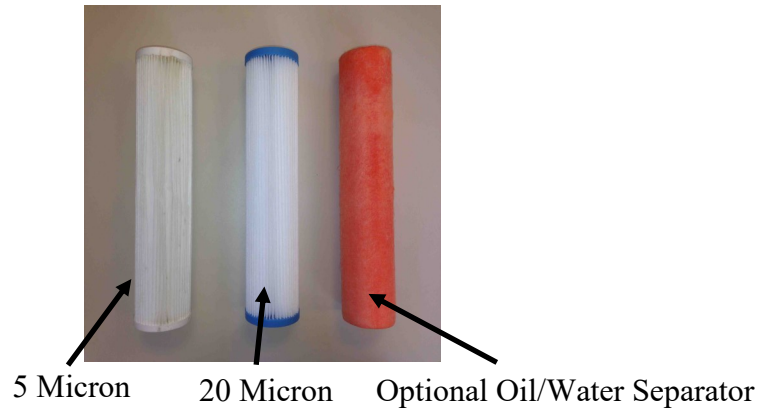

CHARCOAL FILTERS

The charcoal filter element (FT-FTC-CC) removes chlorine from the fresh water flush water supply, as the RO membrane can only handle small amounts of chlorine without permanent damage.

The charcoal filter used for the fresh water flush system will not plug up unless you have very dirty domestic water in your boat's supply tank.

The charcoal filter we supply removes 99.7% of the chlorine. Beware when buying other charcoal filters. If they don't specify the percentage of chlorine removed, don't use them. Cheap ones may remove only 60% or 70%. Also, there are aftermarket filters which are very close to, but not exactly, the right dimensions, and they will not seal in the housing. If you skimp on the charcoal filter you risk damaging a \$600.00 membrane on the first flush. The other factor is the flow rate that the filter can handle. Because the chlorine is adsorbed by the charcoal, it must remain in contact with the charcoal for a sufficient period of time for all of the chlorine molecules to be captured. The filters we use can handle 1.5 gallons (6 liters) per minute flow, and are good for 3000 gallons (12,000 liters) at 1.5 GPM, or six months, whichever comes first. Regardless of the amount of water treated, the charcoal loses its effectiveness after six months.



Charcoal filter, Spectra part number FT-FTC-CC

SHURFLO PUMP WON'T RUN

If the pump has power to it but the pump won't run, first check the pressure switch. The pressure switch (EL-FP-PS) is located on the wet end of the pump and has two red wires plugged into it (see photo, next page). Jump the two red wires together and see if the pump runs. You can safely run the system with the pressure switch jumped, just keep an eye on the feed pressure and don't let system pressure exceed 110 PSI. Replace the switch when a spare is available. The pressure switch should never open unless there is a problem with the system or it is incorrectly adjusted. See Adjust Shurflo Pressure Switch on next page.

If the pump will not run with the pressure switch jumped then it is most likely a problem with the brushes or overheat protection switch inside the motor. The motor will come completely apart by removing the two screws on the end of the motor. Remove the rear cover and paper insulator. Pull out the plastic brush holder. The thermal switch is located on one of the brush leads. With an ohmmeter, check for continuity through the switch. If it is open, you can make temporary repairs by wiring around it, being careful that your new wiring doesn't chafe on the moving parts, nor resist the springs that push the brushes on to the commutator. The overheat switch is unlikely to fail unless the motor has overheated. Consider relocating the pump or improving ventilation if the overheat protection has failed.

If any corrosion is apparent the brushes may be sticking. Once apart clean all the carbon dust from all the parts. Clean the commutator with light sandpaper. Make sure to clean the small grooves on the commutator with a small sharp tool to remove the carbon in between the segments. Adjust the springs on the brush holders so the brushes slide smoothly in and out. If the bearings are rough and binding, remove the rubber dust cover to clean them, grease them, and work them free by hand. Don't service the bearing unless absolutely necessary. Reassemble in reverse order. You can hold the carbon brushes back with paper clips inserted through the slots in the brush holder so they don't hang up on the bearing during assembly. Make sure the corrugated bearing shim doesn't push out. If it does, push it back into place.

ADJUST SHURFLO PRESSURE SWITCH

Shurflo feed pumps are equipped with a high pressure cutout switch (EL-FP-PS). This is the small black unit on the end of the wet end of the pump head (PL-PMP-SFPH) where the two red wires connect. If the pressure switch is not properly adjusted the pump may cut out each time the Clark pump cycles and the feed pressure spikes. When this happens the production will drop and salinity will increase. The points in the switch will fail quickly if set too low because of the constant arcing each time the Clark Pump shifts.

On the very center of the switch is a small 5/64" Allen screw. While running the system close the brine discharge seacock or kink the discharge hose, to block the flow. Watch the pressure gauge and adjust the pressure switch to shut off at 125 psi. Turn the Allen screw clockwise to increase the cut off set point.

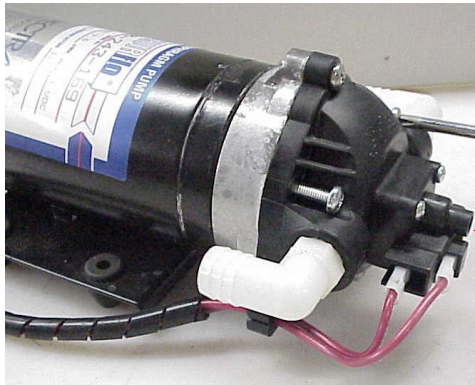



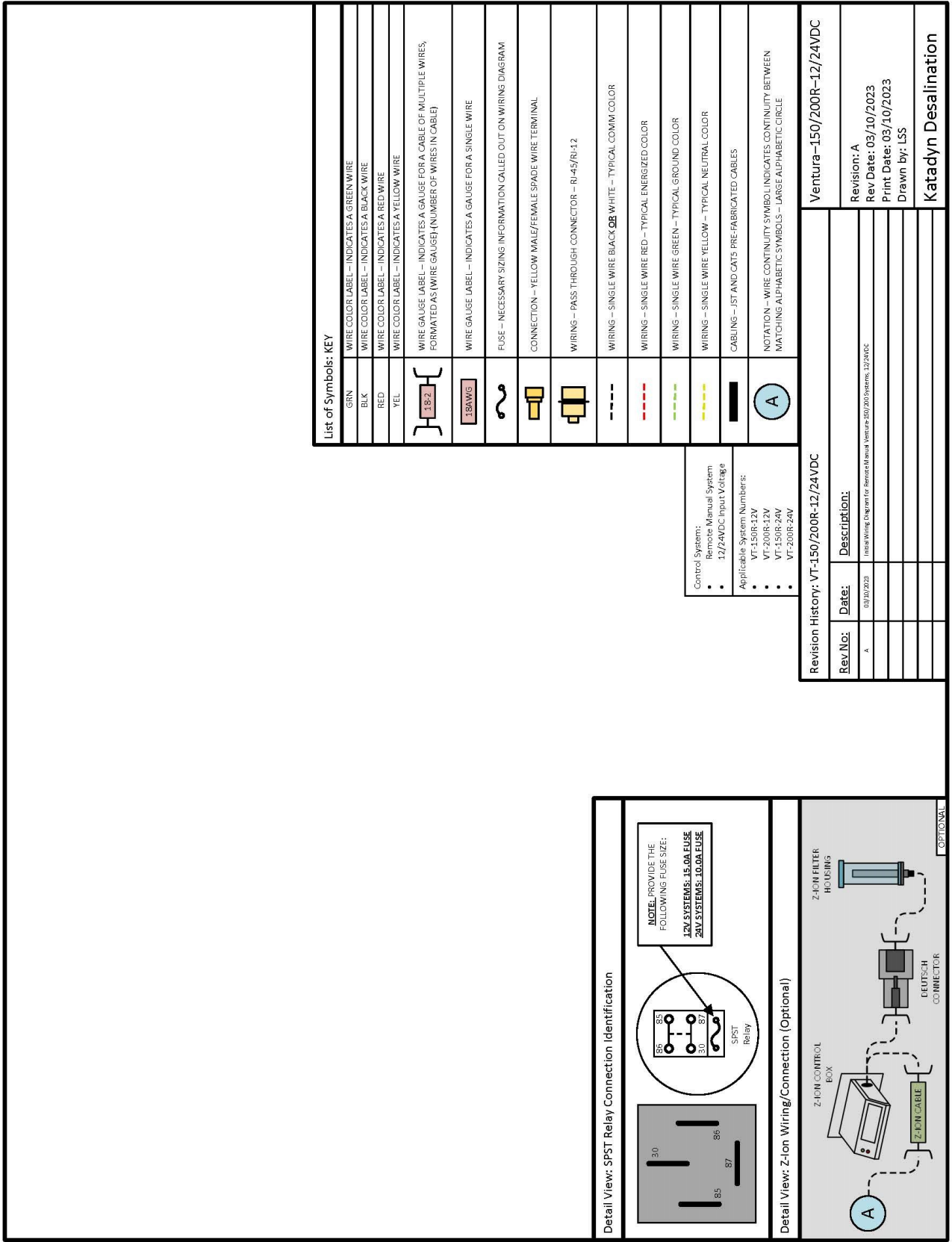

Pressure Switch
Adjusting Screw

Ventura 150 Remote Electrical Diagram







Ventura 150R-200R-T Electrical Specifications





Ventura 150R 12V:

-  **Power Supply Voltage: 12 VDC**
-  **Bench Test: 14 V / 9 A**
-  **Power Consumption: 127 W**
-  **Efficiency: 20 Wh/gal**





Ventura 150R 24V:

-  **Power Supply Voltage: 24 VDC**
-  **Bench Test: 26.2 V / 4.8 A**
-  **Power Consumption: 126 W**
-  **Efficiency: 22.1 Wh/gal**

Ventura 200R 12V:

-  **Power Supply Voltage: 12 VDC**
-  **Bench Test: 13.9 V / 10 A**
-  **Power Consumption: 141 W**
-  **Efficiency: 16.8 Wh/gal**

Ventura 200R 24V:

-  **Power Supply Voltage: 24 VDC**
-  **Bench Test: 14 V / 10.5 A**
-  **Power Consumption: 148 W**
-  **Efficiency: 17.8 Wh/gal**

Exploded Views & Part Numbers

Part Numbers

1-Way Solenoid Valve 12V
PL-SLN-1/4012SV

3/4" 3-Way Valve
PL-VLV-3W3/4

FILTER HOUSING
FT-FTH-10L3PCS

Cooling Fan 12V
KIT-FK-12

CHARCOAL FILTER
 CARTRIDGE
FT-FTC-CC

Feed Pump Heat Sink
EL-FP-FPHS



Ventura Feed Pump Bracket
FM-VT-ITM

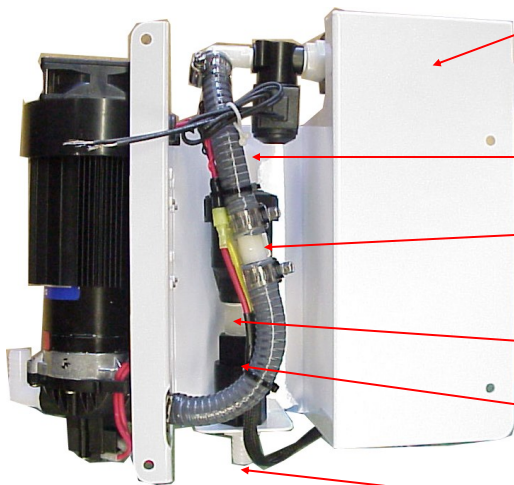

3/4MPTx5/8 HOSE BARB EL
PL-HBE-3/4X5/8

3/4 NYLON STREET EL
PL-MFF-1/2X1/2

3/4MPTX 5/8 HOSE BARB TEE
PL-TEE-3/4M5/8B

NIPPLE
PL-NP-3/4X2

CHECK VALVE
PL-CKV-3/4F-F

3/4MPT X 5/8 HOSE BARB
PL-HBS-3/4X5/8

Pump Head Assembly W/Press. Switch
PL-PMP-SFPH

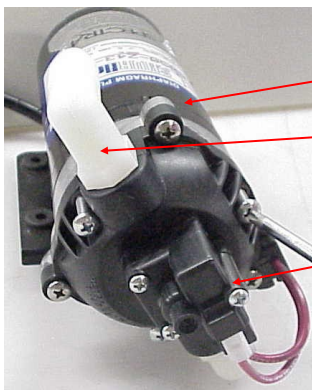

Feed Pump 12V
EL-FP-12V

3/8"NPT X 5/8" Hose Barb El.
PL-HBE-3/8X5/8

Feed Pump Pressure Switch
KIT-FP-SFSK

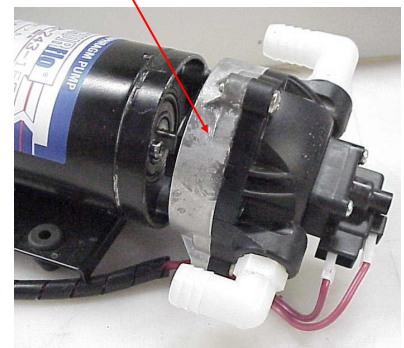

Fig 2

Fig 3

Part Numbers - Cont.



Plate Bracket
FM-PVB-PB

3/8"NPT X 5/8" Hose Barb El.
PL-HBE-3/8X5/8

3/8"NPT Quick Disc.
Coupling Body
PL-QDC-BD3/8



INLET HOSE ASSEM.
SUB-CT-Z-HPILHA

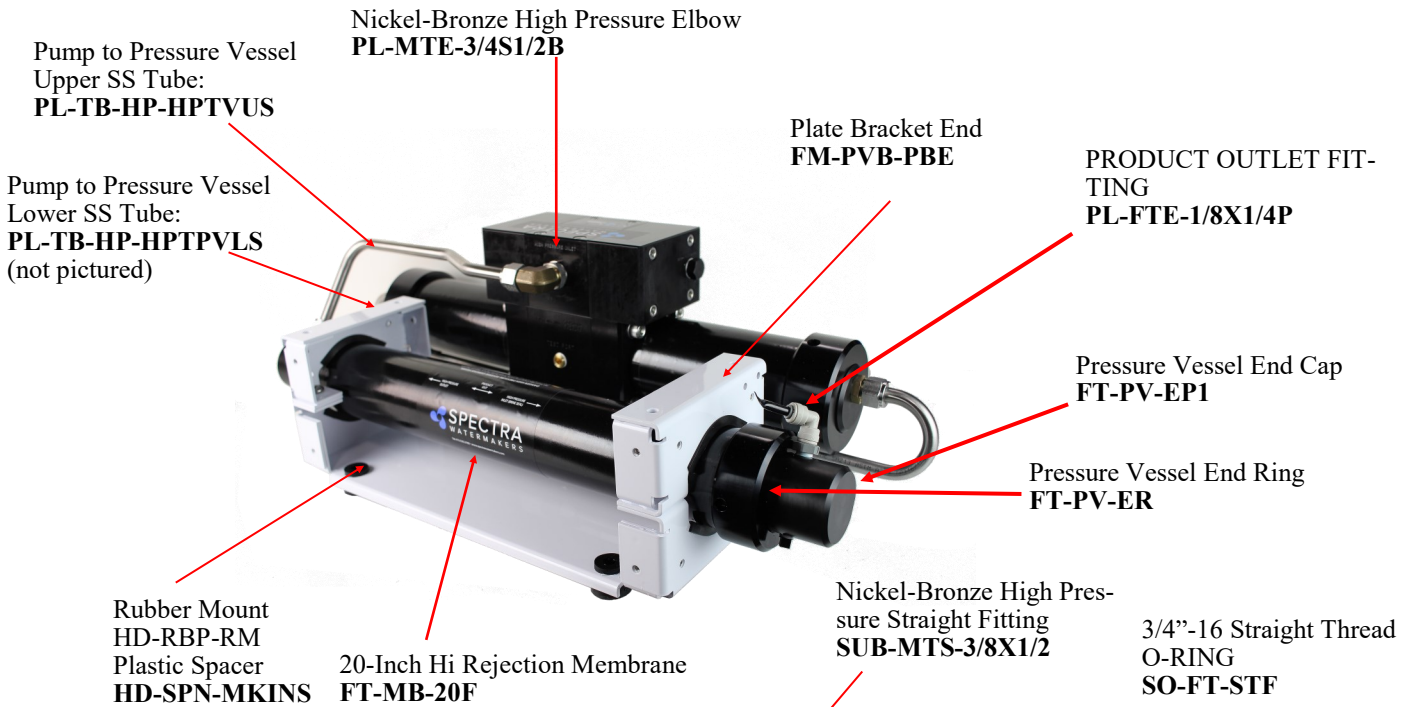

Pump to Pressure Vessel
Upper SS Tube:
PL-TB-HP-HPTVUS

Nickel-Bronze High Pressure Elbow
PL-MTE-3/4S1/2B

Plate Bracket End
FM-PVB-PBE

PRODUCT OUTLET FIT-
TING
PL-FTE-1/8X1/4P

Pump to Pressure Vessel
Lower SS Tube:
PL-TB-HP-HPTPVLS
(not pictured)

Pressure Vessel End Cap
FT-PV-EP1

Pressure Vessel End Ring
FT-PV-ER

Rubber Mount
HD-RBP-RM
Plastic Spacer
HD-SPN-MKINS

20-Inch Hi Rejection Membrane
FT-MB-20F

Nickel-Bronze High Pres-
sure Straight Fitting
SUB-MTS-3/8X1/2

3/4"-16 Straight Thread
O-RING
SO-FT-STF

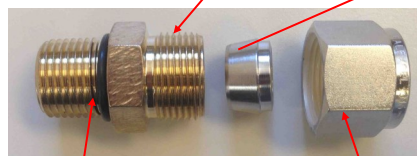

Connector O-RING
SO-HPP-CT

1/2" Stainless Ferrule
PL-HWR-1/2FR

Stainless Fitting Hex Nut
PL-HWR-1/2HN

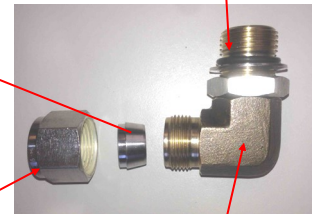

Nickel-bronze high pres-
sure 90 degree fitting
PL-MTE-3/4S1/2B

Part Numbers - Cont.



PRODUCT WATER SAMPLING VALVE
PL-VLV-3W1/4

1/4 TUBE X 1/4 MPT STRAIGHT FITTING
PL-MTS-1/4X1/4P
 or
PL-MTE-1/4X1/4P
 ELBOW FITTING 1/4 TUBE X 1/4 MPT EL (not shown)

Wall Mounting Clamps (not shown):
 (2)**PL-CLP-3/4CAR 3/4" CAR-LON CLAMP**

ACCUMULATOR
PL-ACC-TK



1/2MPT X 5/8 HOSE BARB
PL-HBS-1/2X5/8

1/2" TEE
PL-TEE-1/2FN

1/2" NIPPLE
PL-NP-1/2N

1/8MPT X 1/4 TUBE EL
PL-MTE-1/8X1/4J

PRODUCT FLOW METER
PL-FMT-10

1/4MPT X 1/4 TUBE STRAIGHT FITTING
PL-MTE-1/4X1/4

1/2 X 1/4 BUSHING
PL-BSH-1/2X1/4N

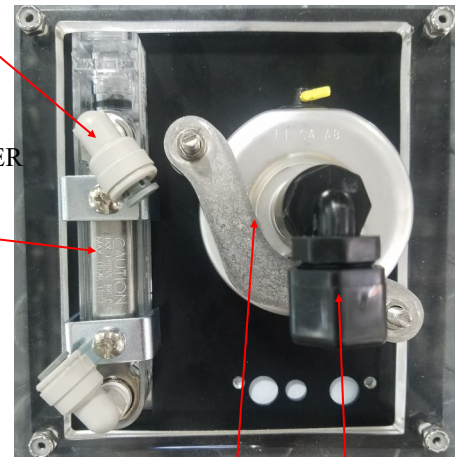

PRESSURE GAUGE
PL-PSG-LP2.5

PREFILTER HOUSING
FT-FTH-10H

5 MICRON FILTER CARTRIDGE
FT-FTC-5



1/8"NPTX1/4" Tube fitting Elbow
PL-SWF-1/8X1/4J

1/4FPT X 1/4 TUBE EL
PL-FTE-1/4X1/4P

SEA STRAINER
FT-STN-5

5" STRAINER O-RING
SO-STN-5S

STRAINER SCREEN
FT-STN-5S

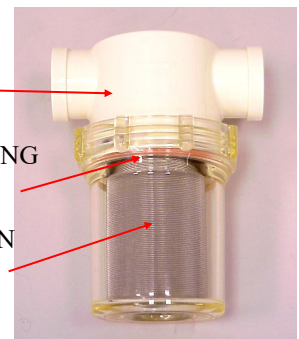

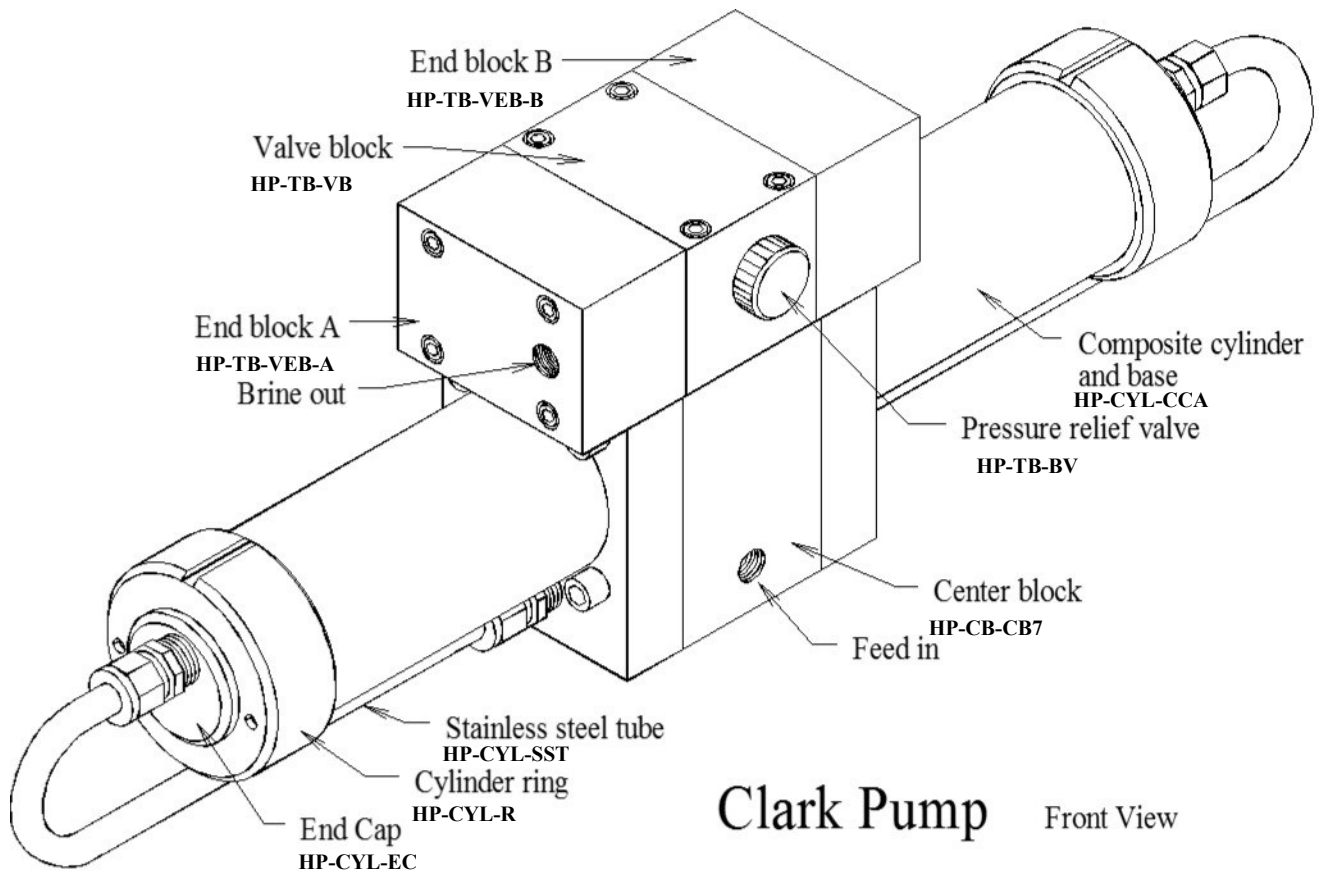

Clark Pump Front View

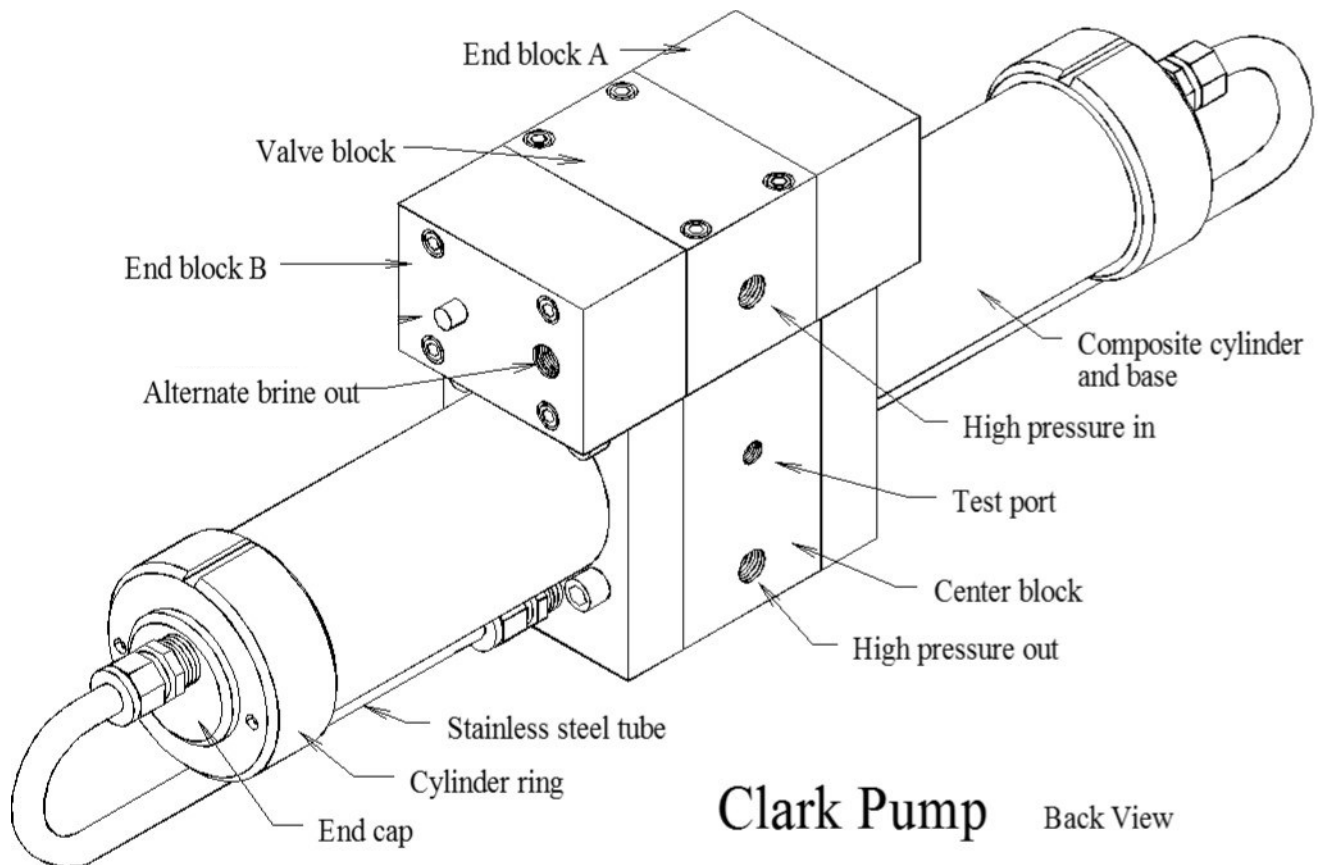

Clark Pump Back View

Spool Assembly
Exploded View

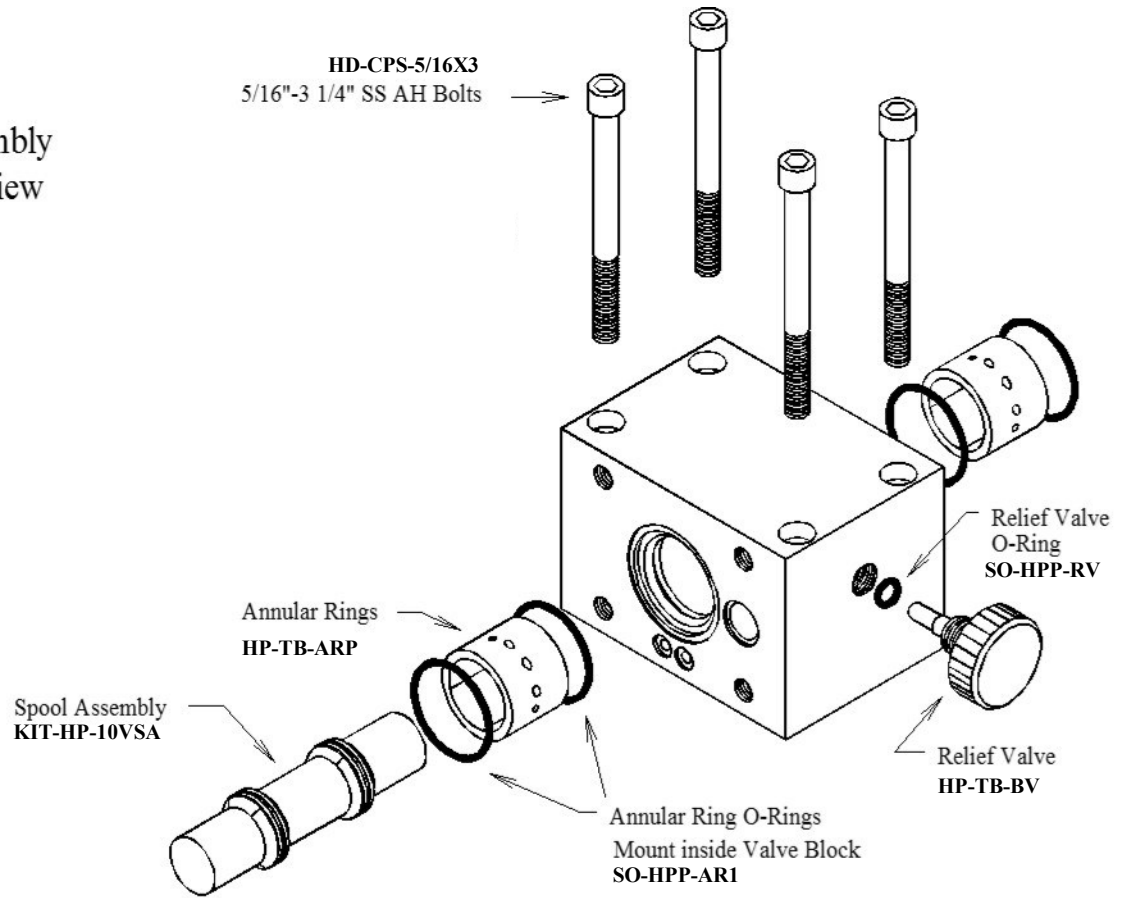

Valve Block

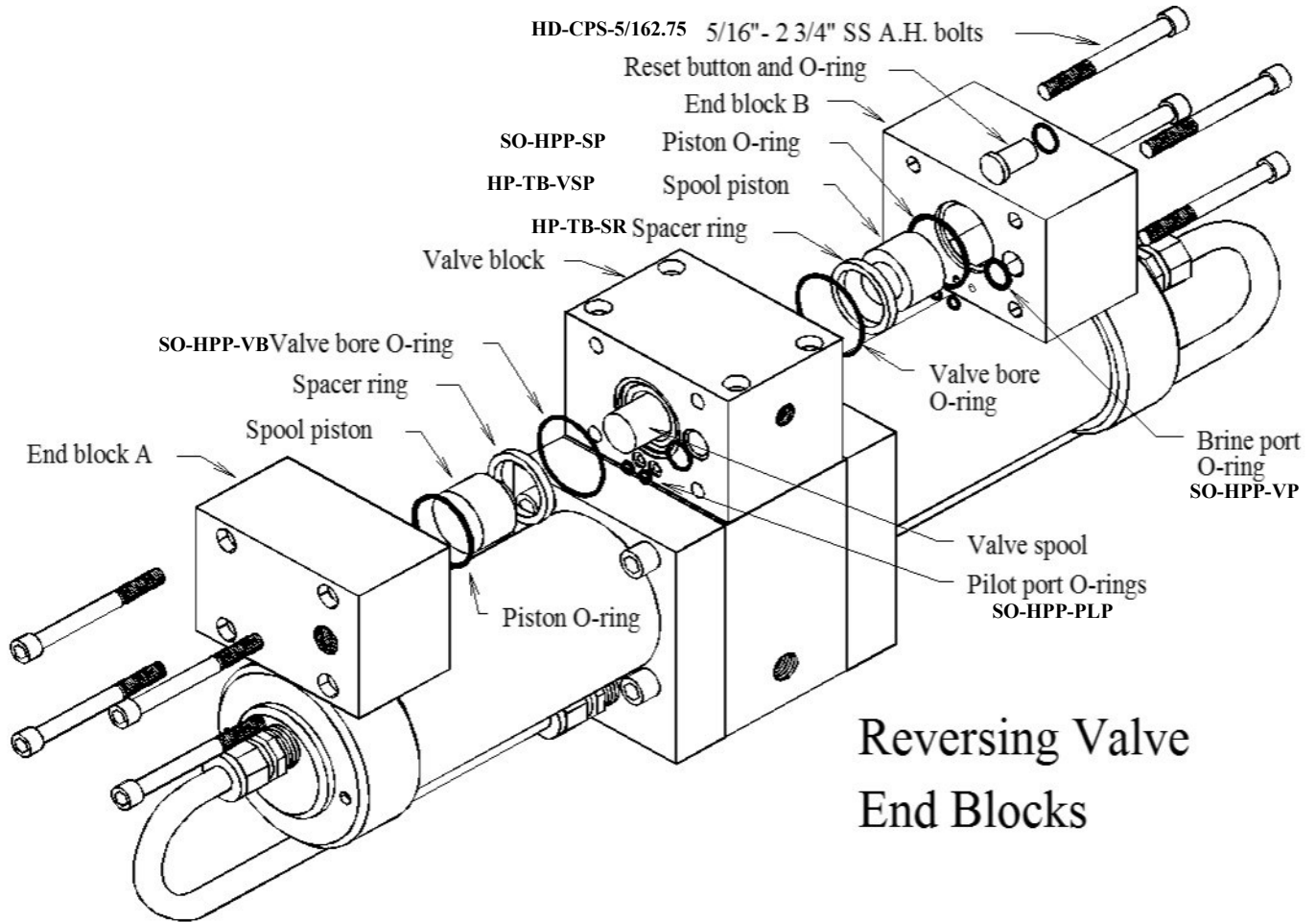

Reversing Valve
End Blocks

Parts

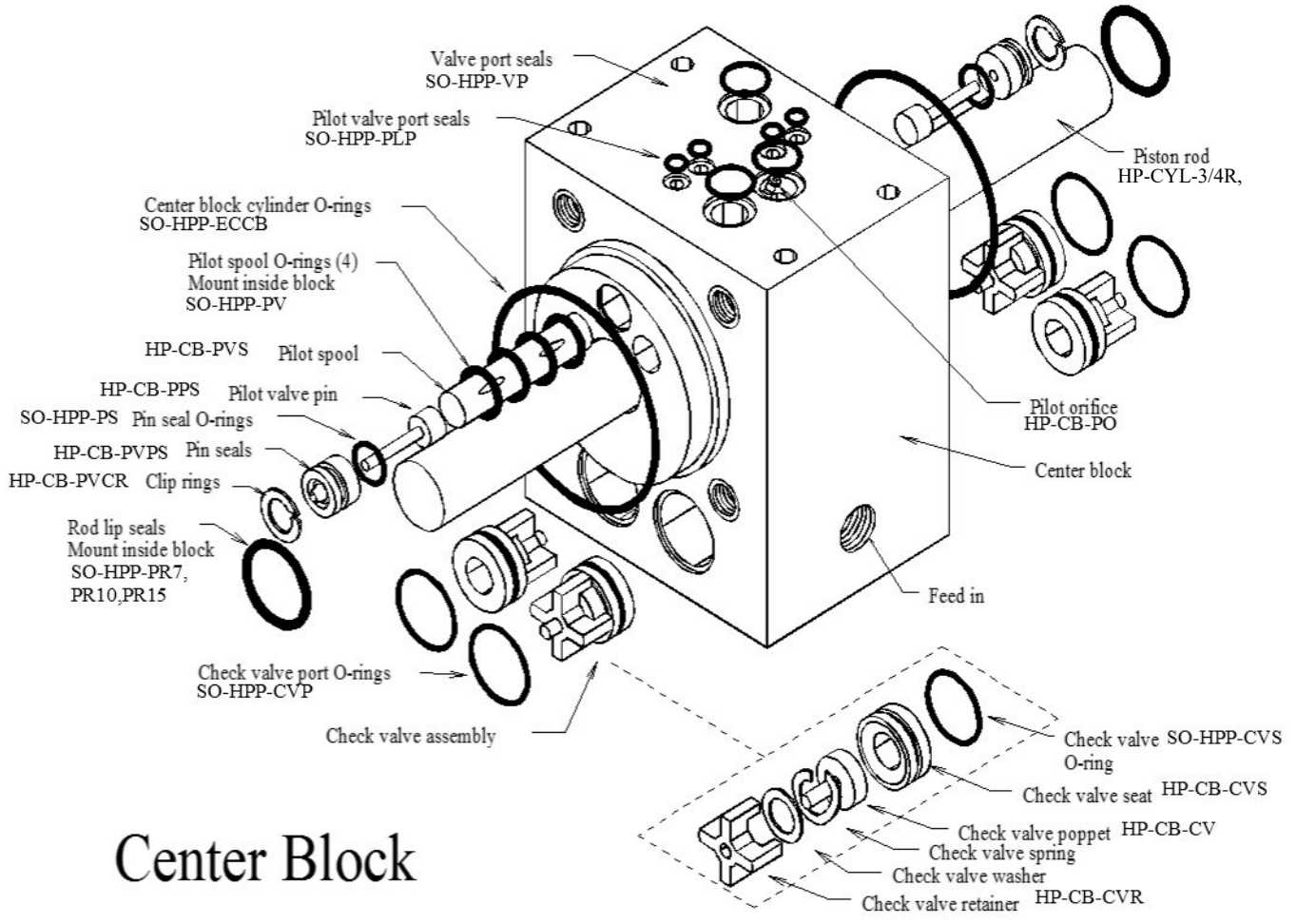

Center Block

Parts

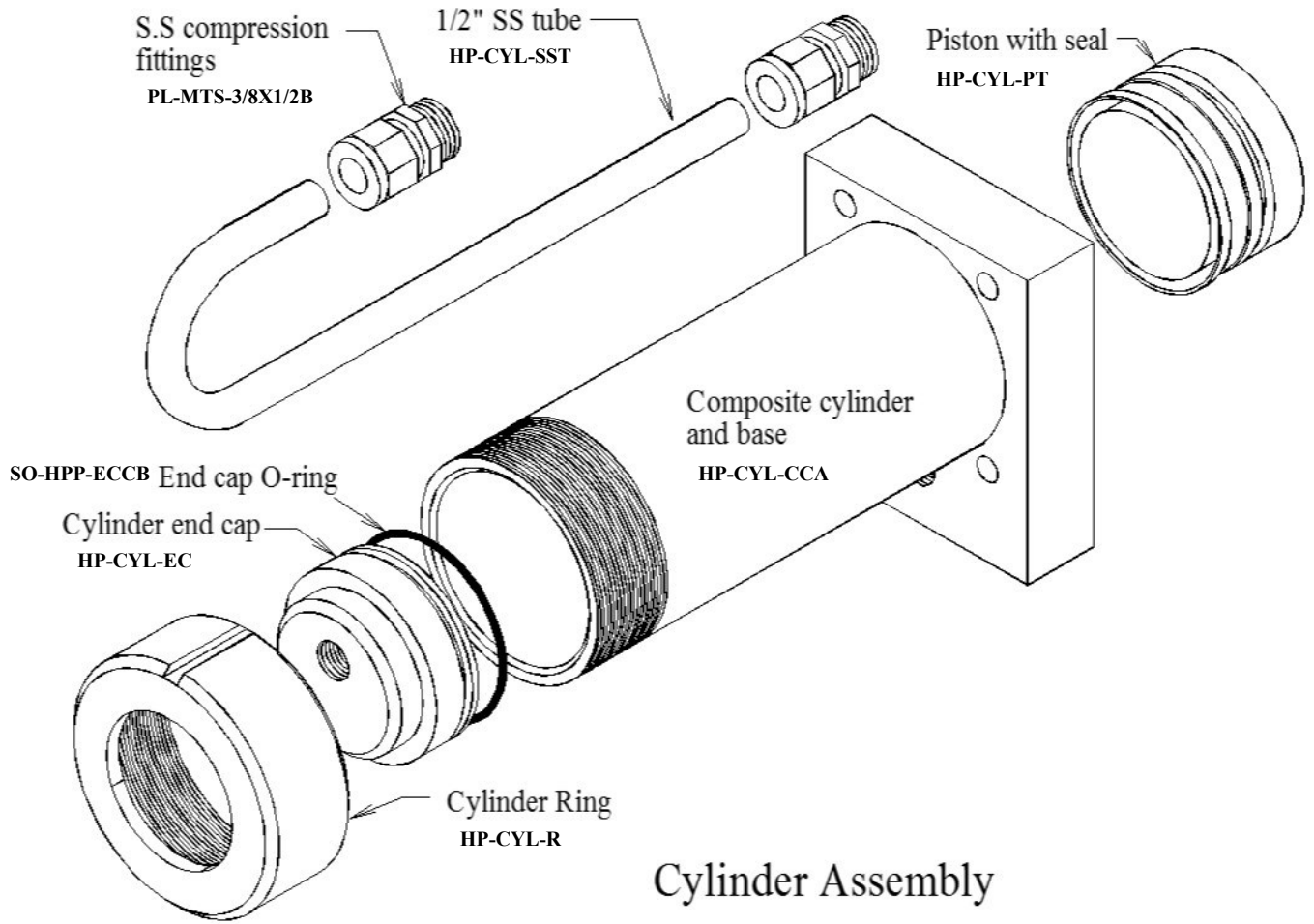

Owner Resources

Spectra Watermakers. Making fresh water worldwide.

Spectra Watermakers is a Katadyn Group Brand.

KATADYN GROUP
SWITZERLAND

SPECTRA WATERMAKERS

SPECTRA WATERMAKERS LIMITED LIFETIME WARRANTY

THIS LIMITED WARRANTY APPLIES TO THE ORIGINAL OWNER OF THE WATERMAKER AND IS NOT TRANSFERRABLE

For warranty information regarding products sold within the European Union please contact europe@spectrawatermakers.com.

This limited product warranty is provided by Katadyn Desalination LLC, a Business Unit of the Katadyn Group. (“Manufacturer” of “We” or “Our”) to the original, consumer owner of the product (“You” or “Your”) with which this limited product warranty is provided (the “Product.”)

The Manufacturer warrants to You that the product will be free from defects in material and workmanship under normal use and regular service and maintenance, subject to the exclusions described below, for a period of 1 year (the “Warranty Period”) after date of installation, or 15 months after the shipment date, whichever comes first. This warranty will be extended for an additional 12-month period when the product is installed and commissioned by a Katadyn Desalination Authorized Installer. A Spectra Watermakers Commissioning Report must also be returned and approved by the factory. The Spectra Clark Pump has a Limited Lifetime Warranty on Marine systems to the original consumer owner of the product, not inclusive of repair or replacement parts due to wear over time. If the Spectra Clark Pump is used in a Landbased application, the product warranty is provided for a period of 1 year (the “Warranty Period”) after date of purchase (if purchaser is installing system) or date of commissioning (if Spectra dealer is installing system).

You will be required to show written documentation supporting the date of purchase or date of commissioning. If you are unable to provide documentation supporting the date of purchase or commissioning, the warranty period shall be based on the product’s date code and will be determined by the Manufacturer’s sole and absolute discretion.

WHAT IS COVERED

Katadyn Desalination LLC. warrants, for the period defined above, that the Product will be free from defects in materials and/or workmanship and will conform to Manufacturers published specifications if installed and maintained in accordance with the Manufacturers Instructions.

WHAT IS NOT COVERED

The Warranty does not include service, repair, or replacement to correct damage caused by improper installation, maintenance, improper connection with water systems, external electrical fault, accident, alteration, misuse, abuse, neglect, negligence, (other than Manufacturer’s), acts of God, failure to install or maintain the product in accordance with the Manufacturers instructions.

DAMAGED OR MISSING PRODUCT

You must examine the Product upon receipt and notify Katadyn Desalination LLC. if any item is damaged or missing within 30 days from the date of the delivery. Damage due to freight must be reported to Katadyn Desalination LLC. and to the freight carrier within 24 hours of delivery.

SOLE WARRANTY

THE WARRANTIES SET FORTH IN THIS SECTION ARE THE SOLE AND EXCLUSIVE WARRANTIES GIVEN BY THE MANUFACTURER WITH RESPECT TO THE PRODUCTS AND ARE IN LIEU OF AND EXCLUDE ALL OTHER WARRANTIES, EXPRESS OR IMPLIED, ARISING BY OPERATION OF LAW OR OTHERWISE, INCLUDING WITHOUT LIMITATION, MERCHANTABILITY AND FITNESS FOR A PARTICULAR PURPOSE WHETHER OR NOT THE PURPOSE OR USE HAS BEEN DISCLOSED TO MANUFACTURER IN SPECIFICATIONS, DRAWINGS OR OTHERWISE, AND WHETHER OR NOT MANUFACTURER'S PRODUCTS ARE SPECIFICALLY DESIGNED AND/OR MANUFACTURED BY MANUFACTURER FOR YOUR USE OR PURPOSE.

WHAT WE WILL DO TO CORRECT PROBLEMS

If You return the defective product during the warranty period and in accordance with the instructions contained herein, shipping prepaid, the Manufacturer shall, at its option and as Your exclusive remedy, repair, correct or replace the product at no charge if the product is found by the Manufacturer to be a valid warranty claim, in Manufacturer's sole discretion. Replacement product may be refurbished and/or different models but will be functionally equivalent to the product or hardware being replaced. Product repaired or replaced during the warranty period shall be covered by the foregoing warranty for the remainder of the original warranty period or ninety (90) days from the date of shipment or purchase, whichever is longer. Contact your Dealer or the Manufacturer's Customer Service at 415-526-2780 to obtain a returns materials authorization (RMA #).

HOW TO MAKE A WARRANTY CLAIM

If You discover any warranty related issues after 30 days, or You have questions concerning Your product or how to determine when service is needed, please contact your local dealer or contact the Manufacturer's Technical Support at 415-526-2780 or email the Manufacturer at techsupport@spectrawatermakers.com. The following information must be provided as part of Your warranty claim: your name, address, phone number, Your products' model number, Your product's 4-digit serial number, and if necessary, upon request, written confirmation of the date shown on Your purchase receipt and the purchase price paid for the product. All products being returned to the Manufacturer must have a return material authorization (RMA) number to be processed. Any item returned to the Manufacturer without an RMA number will not be accepted by the Manufacturer. Contact your Dealer or Customer Service to obtain an RMA number. Once we have received Your returned product, we will determine, in our sole and absolute discretion, whether Your claim is covered by, or excluded from, this limited warranty. Repairs or modifications made to the product by other than the Manufacturer will nullify this limited warranty. Coverage under this limited warranty is conditioned at all times upon the original purchaser's compliance with these required notification and repair procedures.

LIMITATION OF LIABILITY TO THE FULLEST EXTENT PERMITTED BY LAW, IN NO EVENT, SHALL MANUFACTURER OR ITS AUTHORIZED SERVICE REPRESENTATIVES BE LIABLE FOR ANY INCIDENTAL, SPECIAL, INDIRECT, OR CONSEQUENTIAL DAMAGES, INCLUDING ANY ECONOMIC LOSS, WHETHER RESULTING FROM NONPERFORMANCE, USE, MISUSE OR INABILITY TO USE THE PRODUCT OR THE MANUFACTURER'S OR ITS AUTHORIZED SERVICE REPRESENTATIVE'S NEGLIGENCE. THE MANUFACTURER SHALL NOT BE LIABLE FOR DAMAGES CAUSED BY DELAY IN PERFORMANCE AND, IN NO EVENT, REGARDLESS OF THE FORM OF THE CLAIM OR CAUSE OF ACTION (WHETHER BASED IN CONTRACT, INFRINGEMENT, NEGLIGENCE, STRICT LIABILITY, OTHER TORT OR OTHERWISE), SHALL MANUFACTURER'S LIABILITY TO YOU EXCEED THE PRICE PAID BY THE ORIGINAL OWNER FOR THE MANUFACTURER'S PRODUCT.

The term "consequential" damages shall include, but not be limited to, loss of anticipated profits, business interruption, loss of use or revenue, the cost of capital or loss or damage to property or equipment. Some states do not allow the exclusion or limitation of incidental or consequential damages, so the above limitation may not apply to you. This limited warranty gives you specific legal rights, and you may also have may other rights which vary from State to State.

--- CUT HERE ---

Spectra Product Registration Form

Any commissioning/install report (and additional 12 month warranty) may be rejected at the sole discretion of Spectra Watermakers if the system is not installed correctly.

Registration (To be completed by owner)

System Details:			
Model _____	Date of install: _____		
4-digit S/N _____	Clark Pump S/N: _____	Voltage _____	
Dealer/distributor: _____	Boat Location: _____	max speed: _____	

Boat model or type (i.e. Leopard 44, Beneteau 55' powerboat, catamaran, powercat, 42' sailboat...)

What type of boating will you be doing and what will the watermaker primarily be used for:

Original Owner Details:	
Name: _____	Phone Number: _____
Email Address: _____	
Address (Optional): _____	

Submission for Approval:

Please submit this document along with the Installation and Commissioning Reports to Spectra Watermakers for approval. Submissions can be **submitted online**, scanned and emailed, or mailed directly to the factory. Spectra Watermakers Technical Support will email the original owner and the authorized distributor with the status of submission.

Web-Based Format (Preferred option):

spectrawarranty.formstack.com/forms/product_registration

spectrawarranty.formstack.com/forms/spectra_install_commissioning_report

Email: TechSupport@SpectraWatermakers.com

Phone: +1(415) 526-2780

Address: Katadyn Desalination
Technical Department
2220 S. McDowell Blvd Ext
Petaluma, CA 94954
USA

Please keep a copy of these reports for your records.

--- CUT HERE ---

Spectra Watermakers Installation Report

(To be completed by authorized installer)

The following checklist is designed to confirm that the watermaker installation meets Spectra standards. Fill out the checklist as completely as possible. Check any boxes that apply and note any concerns. Please document any discrepancies or concerns with photos.

INLET

- Inlet Seacock is below waterline
- Inlet Seacock is dedicated
- Inlet Seacock is shared
- Inlet Thru-Hull forward facing scoop
- Has strainer
- Has diving snorkel
- Sea chest
- Other

Thru Hull Size: _____ IN/CM

Approximate location on vessel and notes: _____

FEED PUMP MODULE

- Feed pump module is mounted upright
- Clearance for filter cartridge changes
- Intake hoses are free of kinks
- Pressurized domestic water is connected to carbon filter

Distance from waterline: _____ FT/M above"/below" the waterline

HIGH PRESSURE MODULE and BRINE DISCHARGE

- Pressure relief valve is accessible
- Brine discharge has no obstructions and vents to atmosphere

Notes: _____

PRODUCT WATER TUBING

- Product water flows into top of freshwater tank
- Freshwater tank is vented

INSTALLATION SIGN OFF

Technician's Name: _____ Date: _____

Technician's Signature: _____

Distributor/Dealer _____

CUT HERE

Spectra Watermakers Commissioning Report – Page 1

(To be completed by authorized installer)

The following checklist is designed to confirm that the watermaker installation meets Spectra standards and that the system is performing at specification.

Fill out the below checks as completely as possible. Check any boxes that apply and note any concerns.

PURGE

- Storage Chemicals have been purged with PRV open

Length of purge: _____ Minutes

- Diversion Valve is up, in reject position
- Filter condition has been calibrated
- "Run Manual" switch engages full speed
- "Service" switch engages flush speed

RUN HIGH MODE CHECKS

Product Flow: _____ GPH/LPH

Confirmed Product Flow Rate _____ GPH/LPH

- Technician Flow meter. Brand _____
- Hand Measurement _____ Gal/Liters in _____ SEC/MIN

Product Quality: _____ PPM

- Confirmed product quality with handheld TDS meter

Feed Pressure: _____ PSI/BAR

Boost Pressure (with clean prefilters): _____ PSI/BAR

Brine Flow Rate: _____ GPM/LPM

Measurement taken with:

- Technician Flow meter. Brand _____
- Hand Measurement: _____ Gal/Liters in _____ SEC/MIN
- Boost Pump runs
- Output and motor speed decrease when low mode is engaged

Notes: _____

FRESHWATER FLUSH

- Freshwater Flush solenoid valve opens
- Feed Pump is not cavitating when system flushes with seacock closed

Ship's pressurized freshwater pump flow & pressure rating _____ GPM/LPM _____ PSI/BAR

When seacock is open, what is the ppm of brine discharge at the end of the flush _____

Flush duration is _____ Minutes

- Needed to change flush time
- Needed to change speed of feed pump during flush

Notes: _____

*If the system does not have a dedicated forward-facing scoop type thru-hull or will be on a vessel that moves faster than 15 knots the system needs to complete the following sea trial checks. Spectra Watermakers reserves the right to require a sea trial from any customer before approving a commissioning report.

SEA TRIAL

- Watermaker will flush while underway
- Watermaker will start while underway

While the vessel is underway moving _____ KNOTS/MPH/KPH the watermaker is producing _____ GPH/LPH at _____ PPM

Spectra Watermakers Commissioning Report – Page 2

OWNER EDUCATION

Owner has been trained on the following:

Know locations of

- Seacock/Thru-hull
- Sea strainer
- Feed Pump Module
- Prefilter Module
- Freshwater Flush Module
- High Pressure Module
- Control Box and RUN MANUAL toggle switch
- Clark Pump Pressure Relief valve
- Product water inlet to Freshwater Tank
- Brine Discharge location
- Service hoses and storage chemicals
- User Manual

- How to power the watermaker off and on at the main breaker.
- How to run the watermaker.
- How to freshwater flush and the importance of freshwater flushing.
- Knows when the ships domestic freshwater pump is on.
- Knows which prefilter cartridges to use and how to change them.
- Knows how to service the sea strainer module.
- Knows where the carbon block filter is and is familiar with (6 months) service frequency.
- Knows how to run the system via "RUN MANUAL." Including knowing how to bypass the diversion valve and sample the product water before it enters the tank.
- Understands the risks of running the system in run manual.
- Have visually seen the overboard brine discharge (Should know when the system is pumping water).
- Know where freshwater enters the tank, would be able to manually sample/taste water if necessary.
- Understand when the Clark Pump is under pressure and cycling.
- Have seen how the service hoses and bucket are used to circulate seawater or freshwater through the system.
- Have heard the difference speeds of the vane pump (the difference between Run Hi and Service speed.)

Notes: _____
