

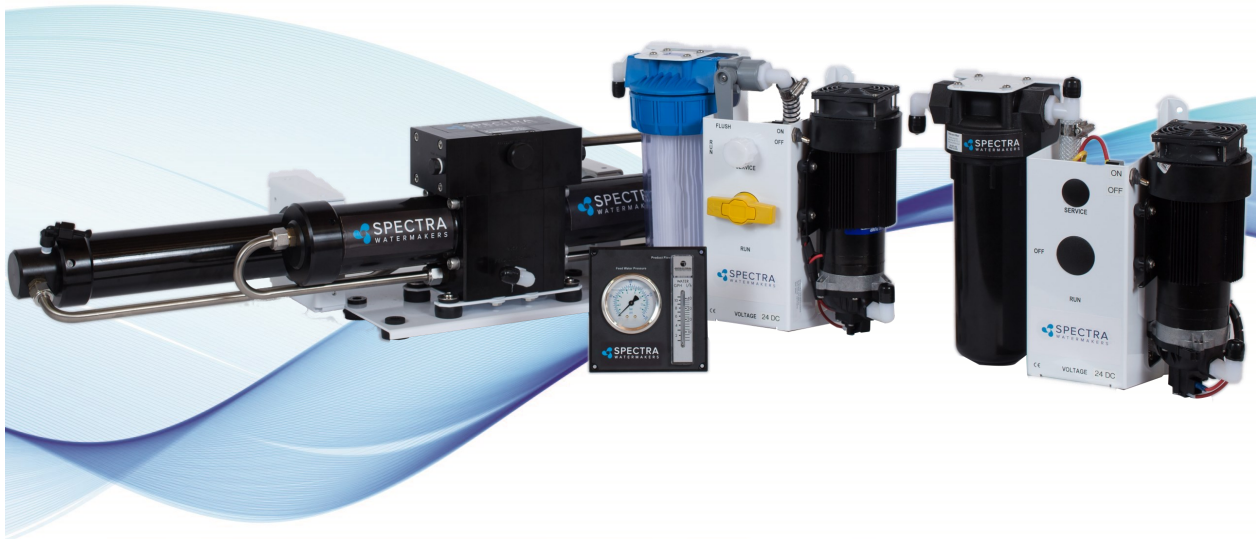

Cape Horn Extreme 330

Installation and Operating Instructions



Spectra Watermakers
Katadyn Desalination LLC.
2220 S. McDowell Blvd Ext. Petaluma, CA 94954
Phone: 415-526-2780 Fax: 415-526-2787
info@spectrawatermakers.com
www.spectrawatermakers.com
Updated January 2024
CH 330 12V/24V.REV1.0



Spectra Watermakers - User Manual Online Access



- Scan QR Code to Visit Spectra Manuals Page.
- Select System, then download the User Manual.
- Reference Commissioning Checklist for important installation requirements.
- Review Installation Basics section of Owner's Manual to ensure warranty compliance.

<http://katadyngroup.ladesk.com/206595-Spectra-Manuals>



Table of Contents

Getting Started.....	4
Installation.....	7
Introduction	8
Installation Basics.....	9
Cape Horn Extreme Plumbing.....	10
Product Water and Pressure Gauge Tube Installation	11
Spectra High Pressure Fitting Instructions.....	12
Cape Horn Extreme Wiring	13
Cape Horn Wiring Specifications.....	17
Optional Z-Ion Installation and Instructions	18
Operation.....	23
New System Startup Procedure.....	24
Dry Testing with an Artificial Ocean.....	26
Normal Operation and Fresh Water Flush.....	27
Optimizing the Fresh Water Flush Duration	28
Service & Maintenance.....	29
Cape Horn Plumbing Diagram.....	30
Suggested Spares	32
Maintenance	33
Introduction to Spectra Chemicals	35
Storage Procedure	37
Winterizing with Propylene Glycol	38
Membrane Cleaning Procedure.....	39
Flow Test	40
Troubleshooting	42
Technical Bulletins.....	45
Parts Identification	51
Owner Resources & Warranty	59
Product Registration, Installation & Commissioning Reports.....	60

Getting Started and Manual Overview

Description of the pictograms

The following symbols will be used in the manual to highlight important indications and warnings:



ATTENTION:

This symbol indicates accident prevention for the operator and / or for any exposed persons.



CAUTION:

This symbol indicates that there is the possibility of damaging the system and / or its components.



DANGER:

This symbol indicates a shock hazard or exposure to risk.



NOTE:

This symbol indicates useful information.



ATTENTION

Important Information Safety Warnings

To safeguard the operator's safety and to avoid possible damage to the machine, before carrying out any operation on the machine, it is essential to read carefully all the instructions manual. Check periodically that no leaks are present. Avoid installing the plant where a leak may cause damage and/or jeopardize the safety of the vessel.

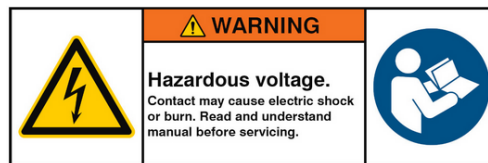
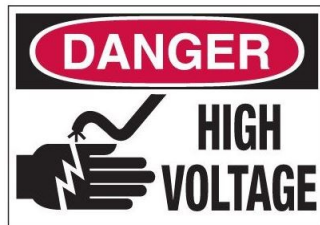

Unpack the system and inspect it for damage during shipping. Freight damage must be reported within 24 hours. Refer to the shipping list for your system to ensure you received all of the components listed. Do not discard any packaging until you have found and identified all of the parts. The small installation parts are listed on the kit list.

Be aware of the caution and warning signage on the system. If box is labeled “Heavy”, please use two people when moving.



ATTENTION

Important Information Safety Warning Cont.

Study the system layout diagram, component photos, and descriptions before beginning installation.



CAUTION: We will not be held responsible for shortages and or freight damage that are not reported within thirty days of the ship date.

Lay out the system. Before starting the installation identify where each module and component will be placed. Insure that there is enough clearance around the components for removal of filters and system service. Make sure you have adequate tubing and hose before starting. Additional parts may be ordered.



DANGER/CAUTION:

Do not use system in ports or polluted seaways.

Cape Horn Extreme Shipping List:



ATTENTION: Please read any warning labels in packaged materials which may include SDS sheets and further documents.

- 10% Clark Pump and reverse osmosis membrane module
- Feed pump module A with fresh water flush system
- Feed pump module B with prefilter
- Accumulator tank assembly
- Analogue gauge assembly
- Installation fittings kit
- 5/8" (147.32 cm) (Hose (2 x 25' (7.6 m))
- Service Kit

Installation

Introduction to the Cape Horn Xtreme

The Cape Horn Xtreme is designed to be efficient, simple, and durable. Properly installed and maintained it will supply years of reliable service. Prudent operation is required with any marine equipment. ***Always maintain enough reserve water to get safely into your next port.***

The Spectra Intensifier, known as the Clark Pump, was introduced in 1997 and has continually improved since. It is built of modern non-corrosive composites and comes with a 40" (101.6 CM) high rejection membrane. The Clark Pump and membrane module are pre-mounted and plumbed together as a single unit to save time and add reliability.

Quick disconnect fitting to facilitate maintenance.

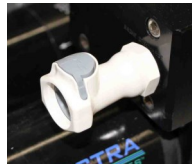

Front View

Pressure Relief Valve

Double rubber mounts to absorb vibration

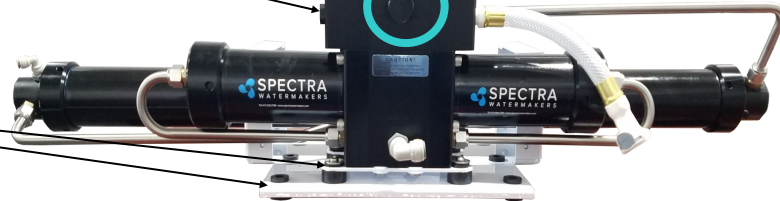

Charcoal Filter and Housing

Fresh Water Flush Valve

On/Off Switch

Cooling Fan

Motor

Shurflo pump head

On/Off Switch

5 Micron Filter and Housing

Service Port
Service Valve



Feed Pump Module A:

Includes primary feed pump, switch, cooling fan, charcoal filter, flush valve, service valve, and service port. The module has compact and streamlined plumbing. The cooling fan increases longevity.

Feed Pump Module B:

Includes secondary feed pump (same as in module A), 5 micron filter housing, and power switch.



NOTE: If your system came with the optional Z-Ion, the Z-Ion unit will replace the charcoal filter housing in Feed Pump Module A. The photo above, and all subsequent photos of feed pump module A, will look slightly different. See Z-Ion installation and instructions on page 17.

Installation Basics



ATTENTION:

- **Read the directions!**
- Avoid tight hose bends and excessive hose runs.
- Use heavy gauge wire.
- Install the feed pump module as low as possible.
- The boost pump module must be installed below waterline.
- Use a dedicated thru-hull with scoop-type strainer.
- Do not mount components over electrical devices.
- **Avoid getting dirt or debris into the piping or hoses during assembly.** A small bit of debris can stop the system!
- **Check that no hoses are kinked or restricting flow.**

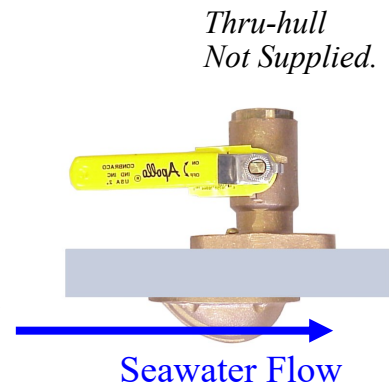

Thru-hull Location: The system must be connected to a dedicated 3/4" (1.91 cm) to 1" (2.5 cm) forward-facing scoop-type intake thru-hull and seacock.

Install the thru-hull intake as far below the waterline and as close to centerline as possible to prevent air or contamination from entering the system. Do not install the intake close to, or downstream of a head discharge, keel, stabilizer fins, or other underwater fixtures.

Thru-hulls near the bow are susceptible to air intake in rough conditions. Sharing a thru-hull can cause flow restrictions, intake of air bubbles or contaminants, and will void the warranty. For racing boats and high speed boats traveling above 15 knots, a retractable, snorkel-type thru-hull fitting is preferred because it picks up water away from the hull.

The brine discharge thru-hull should be above the waterline, along or just above the boot stripe, to minimize water lift and back pressure.

Double clamp all hose connections below the waterline.

Avoid restrictions or long hose runs along the intake plumbing, from the thru-hull to the feed pump module.

Secure the piping away from moving objects such as engine belts and hatches. Prevent chafe on the tubing as required. After several hours of operation, inspect all piping and hose clamps for leaks.

Pipe Fitting Instructions: To seal plastic-to-plastic fittings, wrap 6 to 8 layers of Teflon tape around the threads. Hold the fitting in your left hand and tightly wrap the threads clockwise. For smoother assembly, do not tape the first (starting) threads.

Wiring

- Pay attention to wire size or system performance will be impaired
- Perform wiring to UL, ABYC, CE or applicable standards

Cape Horn Xtreme Plumbing

 **NOTE:** Brine discharge may be connected to either side of Clark Pump



Brine discharge thru hull (not included): place above waterline or tee into another visible drain.

Spectra Clark Pump and Pressure Vessel/ Membrane: Mount in a cool location (below 120°F/49°C). May be oriented in any position and can be well above waterline. Leave access to the pressure relief valve. Do not mount over electrical equipment. Use supplied spacers and washers for the vibration mounts.



Accumulator Tank: Dampens pulsations in feed line

Fresh water from boat's pressure water system

Feed Pump Module B: Same instructions as Feed Pump Module A

 **CAUTION: Feed Pump Module A:** Mount vertically as low as practical, no more than 3' (0.91 m) above waterline and not over electrical equipment, or anything that will be damaged by water. Leave at least 2" (5.08 cm) of clearance below for filter changes.



Use the supplied 5/8-inch (15.9mm) clear braided vinyl hose for all runs. More hose may be ordered from Spectra, or bought at a hardware or marine store.

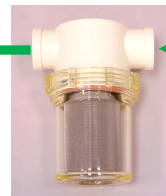

Sea Strainer: Mount with supplied Quick Block and wire tie.



Intake thru-hull

Product Water Plumbing and Pressure Gauge Tube Installation

Sampling Tap for testing the product water.

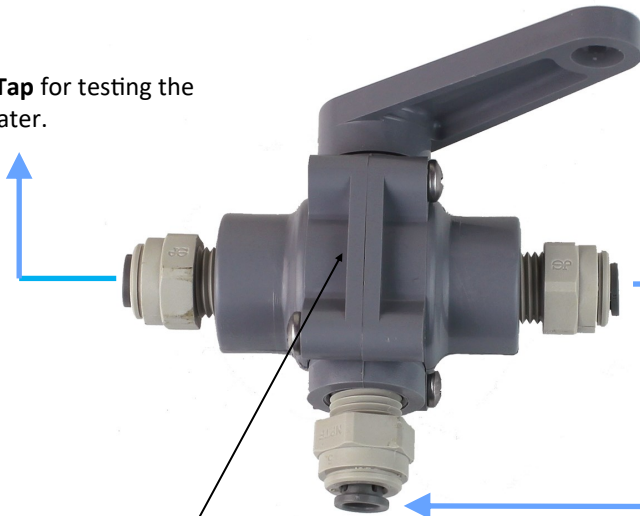

Product to tank: Route the product water from the valve into the top of a vented tank. Install a tee in the water fill or tap a pipe thread into an inspection port.



CAUTION: DO NOT! feed the product into a vent line, manifold, or the bottom of the tank. Make sure that there is no restriction in this piping. **Pressure in the product tubing must never exceed 5psi (.3bar)**, running or stopped, or the membrane will be permanently damaged.

Product Sampling Valve: Mount using the supplied plastic straps. **Note: the handle points in the direction of flow.**



Use accumulator port to connect the pressure gauge with the supplied 1/4" black nylon tubing. Tubing must be pressure rated to 150 PSI (10 BAR).

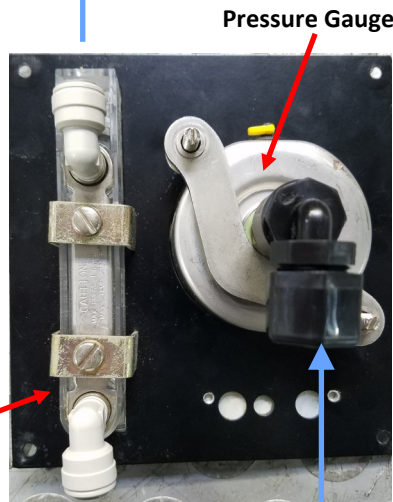

Pressure Gauge

Product Flow Meter

Back view of instrument panel

Use the supplied 1/4" black tubing for the product water plumbing.

Product output fitting.



Spectra High Pressure Fitting Instructions

The Cape Horn Xtreme has eight high pressure fittings, two on each cylinder on the Clark Pump, two on the pressure vessel end caps, and two 90-degree elbows on the back of the Clark Pump. As the compression fitting is tightened, it compresses a ferrule onto the stainless tubing, fixing the ferrule permanently to the tube and holding the compression nut captive.

The body of the fitting seals to the underlying component with an O-ring. On the Clark Pump cylinders and the end caps this O-ring is compressed by tightening the entire fitting. The O-rings on the 90-degree fittings on the back of the Clark Pump have captive nuts and washers, which compress the O-rings without turning the entire fitting.

If a tube fitting leaks it can sometimes be resealed by just tightening. You must use two wrenches, a 13/16-inch wrench to hold the base, and a 7/8-inch wrench to turn the compression nut. The 13/16-inch wrench will need to be thin so as not to interfere with the compression nut. If this doesn't work, disassemble the fitting, grease liberally with silicone grease (the ferrule and the threads) and re-tighten firmly.

The base O-rings should be **gently** compressed to achieve a good seal, and may be damaged by overtightening.

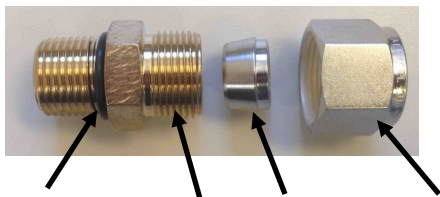

Connector O-ring

Ferrule

Stainless Fitting Hex Nut

Nickel-Bronze High Pressure Straight Fitting



Nickel-Bronze High Pressure Elbow

Cape Horn Extreme Wiring



DANGER:

The Cape Horn Xtreme has two feed pumps, which may be operated independently. For maximum production, both pumps are run at the same time. To save power, or to reduce operating pressures, the system is run on a single pump. There are two main ways to wire the system: Method 1 is the standard installation, and preferable in most cases.

Method 1: Two Pairs of Wires from Distribution Panel to Feed Pumps

Route two pairs of wires, as in the diagram below, from two fuses or breakers on the main distribution panel. With switches or breakers on the distribution panel, this method allows you to control the pumps remotely, which is helpful if the system is difficult to reach. You may also control the system from the switches on the individual feed pumps during maintenance.

Refer to wire guides below. Wire length is the sum of the length of the positive and negative wires. **Example:** In a 12-Volt system, 15 feet of duplex wire (two wires in a protective cover) is needed to connect the DC electrical panel to each feed pump module: $15 + 15 = 30$ (the round-trip length), so you would use #8 Gauge (16mm^2) wire for each feed pump.

Connect wires using supplied terminal blocks, then seal connectors. *Voltage drop will impair performance of the system.*

Wire size guide for 12-Volt system, with a pair of wires led to each feed pump module. Protect each with 15 Amp Fuse or Circuit Breaker

#10 Gauge (10mm^2) up to 25 feet (7.5M)

#8 Gauge (16mm^2) up to 35 feet (10.6M)

Wire size guide for 24-Volt system, with a pair of wires led to each feed pump module. Protect each with 7.5 Amp Fuse or Circuit Breaker

#14 Gauge (4mm^2) up to 10 feet (3M)

#12 Gauge (6mm^2) up to 25 feet (7.6M)

#10 Gauge (10mm^2) up to 35 feet (10.6M)

Cape Horn Extreme Wiring - Cont.

Method 2: One Pair of Wires from Distribution Panel to Cape Horn Xtreme

To streamline the wiring, one of the terminal blocks for the feed pump modules may be eliminated, with the power leads for both feed pump modules led to a single terminal block. Route a single pair of heavy wires from a fuse or breaker on the main DC electrical panel to the terminal block. By this method the whole system may be powered on and off from the main distribution panel, but the individual feed pump module switches must be used to control each pump.

The main supply wires will be protected by a fuse or breaker on the main distribution panel, sized to protect the supply wires, at least 20 Amp. Each individual feed pump must still have overcurrent protection. The simplest way to do this is to add in-line fuse holders (installer provided) to the positive wires between the terminal block and feed pumps. On 12-Volt systems each pump should be protected with a **15 Amp fuse**; on 24-Volt systems each pump should be protected with a **7.5 Amp fuse**.

Refer to wire guides below. Wire length is the sum of the length of the positive and negative wires. **Example:** In a 12-Volt system, 7 feet of duplex wire (two wires in a protective cover) is needed to connect the DC electrical panel to the terminal block for the feed pump modules: $7 + 7 = 14$ (the round-trip length), so you would use #10 Gauge (6mm^2) wire.

Connect wires using supplied terminal block, then seal connectors. *Voltage drop will impair performance of the system.*

Wire Size Guide for 12-Volt system, for a single pair of wires to Cape Horn Xtreme.

Protect individual feed pumps with 15 Amp fuses.

- #10 Gauge (6mm^2) up to 15 feet (4.5M)
- #8 Gauge (10mm^2) up to 25 feet (7.5M)
- #6 Gauge (16mm^2) up to 35 feet (10.6M)

Wire Size Guide for 24-Volt system, for a single pair of wires to Cape Horn Xtreme.

Protect individual feed pumps with 7.5 Amp fuses.



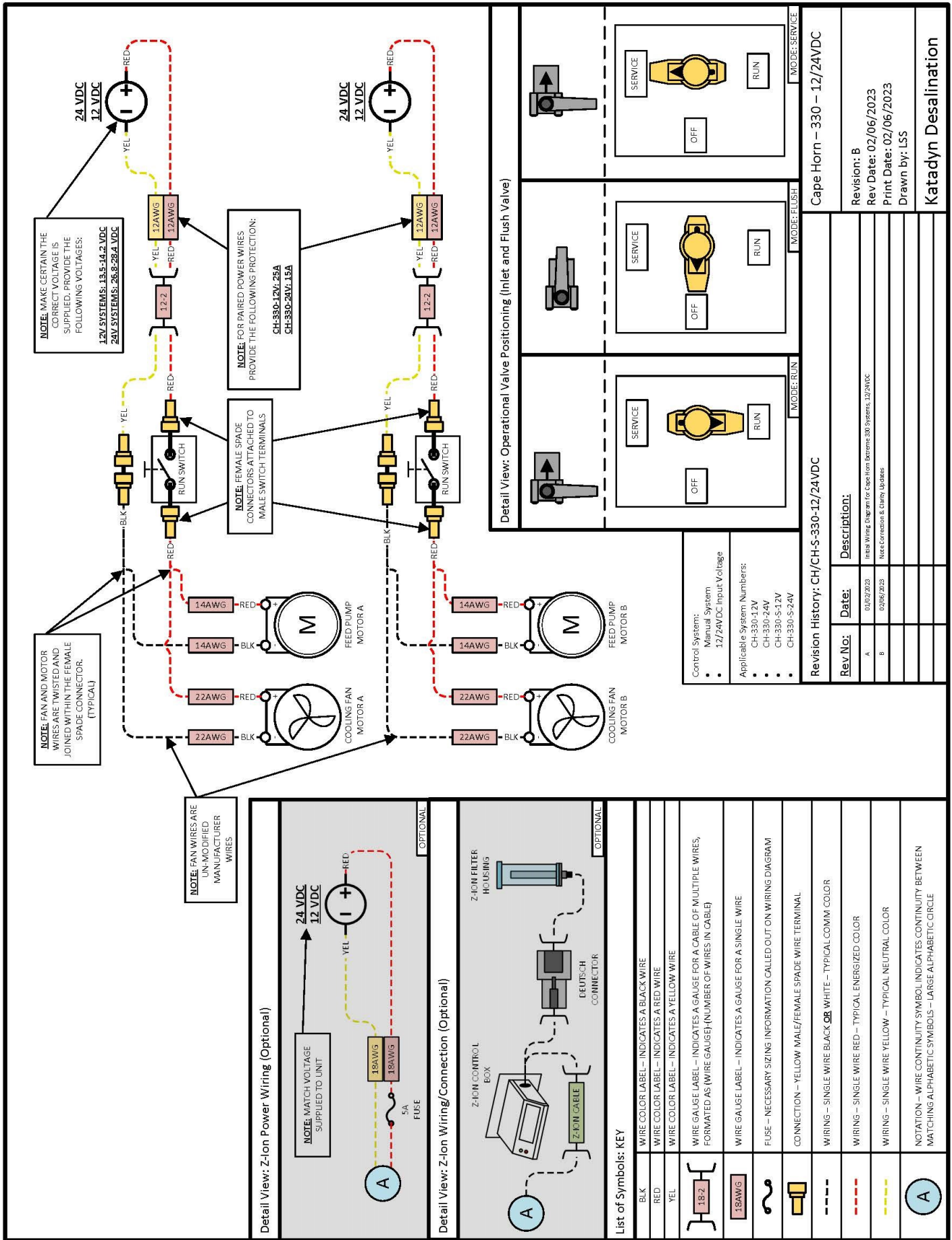

- #12 Gauge (4mm^2) up to 10 feet (3M)
- #10 Gauge (6mm^2) up to 25 feet (7.6M)
- #8 Gauge (10mm^2) up to 35 feet (10.6M)

Cape Horn Extreme 330 Electrical Diagram







Cape Horn Extreme 330 Electrical Specifications





CAPE HORN EXTREME 12V W/SHORT

-  **Power Supply Voltage: 12 VDC**
-  **Bench Test: 13.3 V / 19.5 A**
-  **Power Consumption: 259 W**
-  **Efficiency: 18 Wh/gal**





CAPE HORN EXTREME 24V W/SHORT

-  **Power Supply Voltage: 24 VDC**
-  **Bench Test: 26.9 V / 10.2 A**
-  **Power Consumption: 277 W**
-  **Efficiency: 19 Wh/gal**

CAPE HORN EXTREME 12V W/LONG

-  **Power Supply Voltage: 12 VDC**
-  **Bench Test: 13.9 V / 20.3 A**
-  **Power Consumption: 283 W**
-  **Efficiency: 19 Wh/gal**

CAPE HORN EXTREME 24V W/LONG

-  **Power Supply Voltage: 24 VDC**
-  **Bench Test: 27.2 V / 10 A**
-  **Power Consumption: 273 W**
-  **Efficiency: 18 Wh/gal**

Optional Z-Ion Protection System

The Z-Ion, developed by Spectra, protects the entire system from fouling for extended periods without fresh water flushing or storage chemicals (pickling).

The Z-Ion achieves this end by introducing a stream of metallic ions into the fresh water flush water, thus flooding the entire system with ions that prevent biological growth for up to thirty days. If you are going to let your system sit idle for longer than thirty days, you will still need to treat it with SC-1 storage chemical or propylene glycol.

The Z-Ion will not prevent freezing, so in freezing climates pickling with propylene glycol is still required. Even with the Z-Ion there may still be cases when you need to pickle your system with SC-1 storage chemical or propylene glycol, so we recommend you carry one of these products at all times.

If your system was ordered with the Z-Ion, it will require only some basic wiring and commissioning, laid out in the following pages.

If you didn't order your system with the Z-Ion, it can be retrofitted to any Spectra system.



NOTE: Contact Spectra for more information at: techsupport@spectrawatermakers.com

Z-Ion Installation

NOTE: If you did not order your Cape Horn Xtreme with the optional Z-Ion you may disregard this section of the manual.

If you ordered your Cape Horn Xtreme with a Z-Ion, the feed pump module will come with the Z-Ion installed in place of the standard fresh water flush module, as shown, with a separate Z-Ion electronic control box:

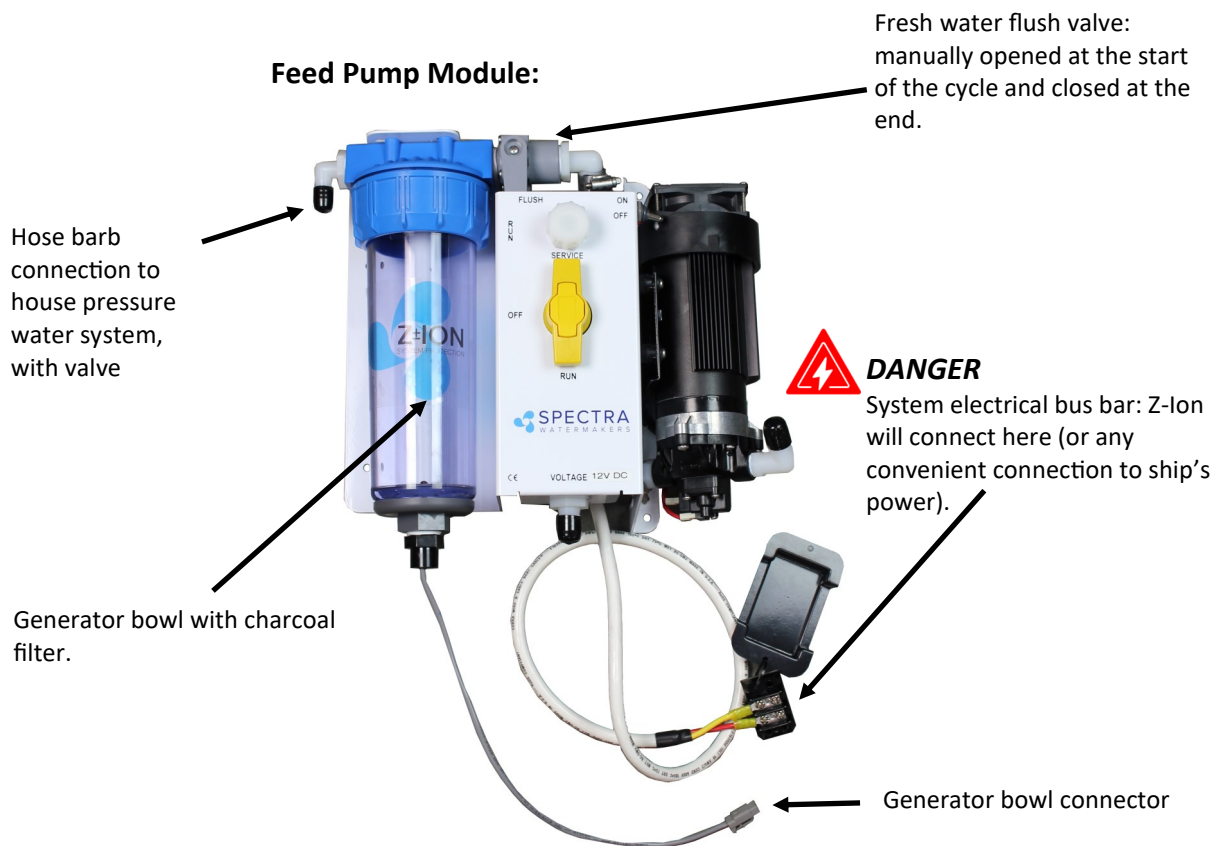

DANGER
Control Box:

Z-Ion control box: Mount in a visible location near the feed pump module.

On/Off switch

Connector for generator bowl

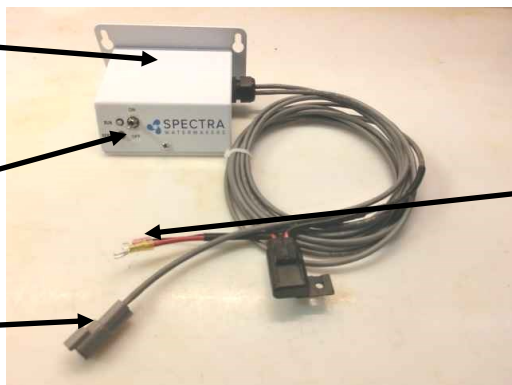

Z-Ion power cable with in-line fuse: Connect to the system electrical bus or other source of ship's power.

Z-Ion Installation - Cont.



DANGER

Z-Ion Power Connections

Turn the main DC breaker off or remove the main power fuse to the watermaker.

Locate the DC Bus Bar for the watermaker (or any other DC power source), as shown below. Connect the DC power leads from the Z-Ion Control Box to the Incoming DC Bus Bar.

- Pay attention to polarity!
- Connect Red (fuse) to DC +
- Yellow (or black) to DC -
- Replace protective cover

Z-Ion Fuse holder: Install in a dry location with easy access.

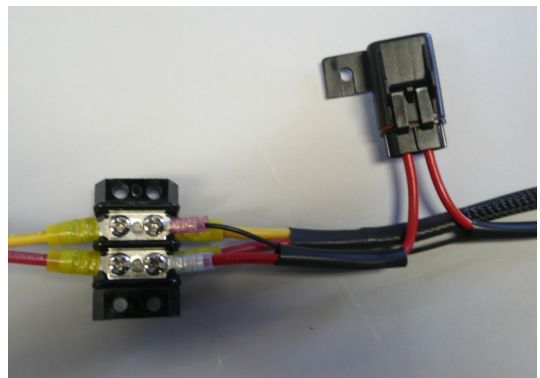
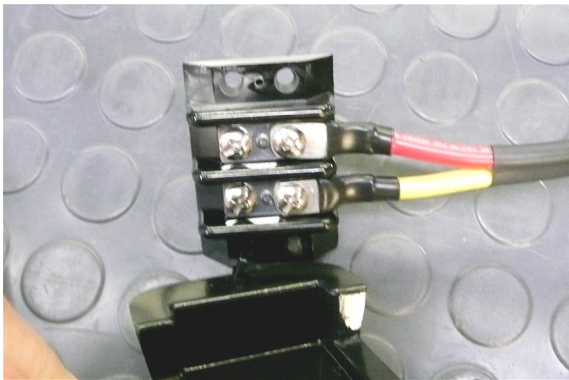

Connection from generator bowl to control box:

The pigtail from the control box has a water-tight connector, which connects to the pigtail from the generator bowl:

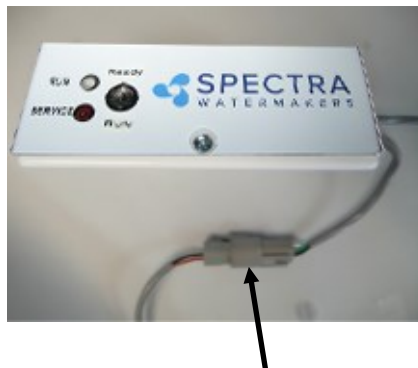

Z-Ion Operation

The Z-Ion should be energized at all times, but will only consume power when operating. Upon initial power-up the LED will flash red/green and then will turn solid green.

Follow the instructions for Normal Operation and Fresh Water Flush. For treatment with the Z-Ion, the process is identical, only the Z-Ion will release silver and copper ions into the flush water when you turn on the generator with the on/off switch. Turn on the ion generator at the same time that you open the flush valve.

The operation cycle begins and the LED will flash green/amber. The cycle will continue until you turn off the ion generator or the adjustable timer times out (factory set for 15 minutes).

Turn off the ion generator at same time that you close the flush valve. If you forget to turn off the ion generator, the Z-Ion will time out after 15 minutes, so no harm will be done to the unit.

If the voltage is out of range, below 10V or above 56V, the LED will flash red every two seconds and the unit will shut down.

Each fresh water flush with the Z-Ion will protect your watermaker for up to 30 days, after which the process must be repeated.

After 720 cycles the service light on the front of the control box will light up, indicating that the probes on your Z-Ion may be wearing down, and should be tested. The service light is just a reminder, and the Z-Ion will go on functioning while it is lit.



DANGER: To reset the service counter, touch two magnets, at the same time, to the two red reed switches on the Z-Ion circuit board, labeled Switch 1 and Switch 2 below.

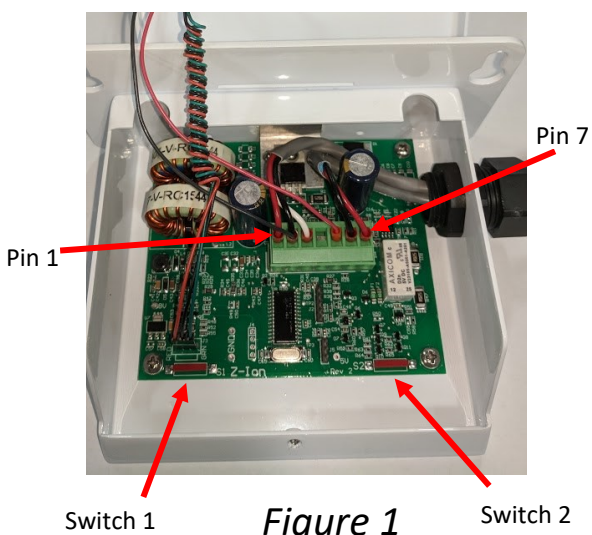

Figure 1

Z-Ion Operation – LED Status Lights & Pinout Info

- Power-up indication – *Fast red/green flash for a few seconds*
 - Ready/Idle – *Solid green*
 - Generating (during a flush) – *The LED will quickly flash at a programmed interval (factory set to 17 seconds between flashes) The flash color will alternate between green and amber and will be off in between voltage spikes. The color change symbolizes the polarity alternating from positive to negative.*
 - Bad power – *Fast red flash followed by shut down*
 - High temperature – *Fast red flash*
 - Service/Cycle Counter Limit - *Slow red flash*
- There are 7 pins on the phoenix connector from left to right in Figure 1.*

Pin 1 Supply Voltage- Battery (+)	Pin 4 Auxiliary Output 1
Pin 2 Ground	Pin 5 Auxiliary Output 2
Pin 3 Trigger	Pin 6 To Zion generator (bowl). No polarity.
	Pin 7 To Zion generator (bowl). No polarity.

Operation

New System Startup

Every new system is shipped from the factory with nontoxic, food-grade propylene glycol. Propylene glycol, Spectra Chemicals, or anything other than seawater or freshwater must be purged from the system with the pressure relief valve open at least 1/2 turn. You can purge your system with seawater or freshwater via the Spectra's freshwater flush function. The system must be purged for a minimum of 60 minutes, or until at least 40 gallons (151.42 liters) of water have moved through the system.



CAUTION: Damage will occur if the purge process is not properly followed and the membrane is pressurized with chemicals in it. Check that no hoses are kinked or restricting flow.

Follow this procedure for starting a new system the first time, and after a system has been stored or cleaned with chemicals.

1. First check that:

- All of your hose connections are tight.
- The green warning tag and washer have been removed from under the pressure relief valve.
- The pressure relief valve is open at least 1/2 turn.
- The sampling valve is set to the sample position.
- The brine line is able to freely discharge

Remove Tag and Washer

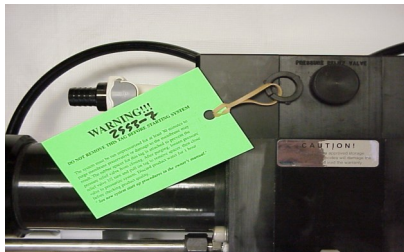

Open 1/2 Turn



Sampling Tap to Sample



For a purge with seawater

- Move to an area free of contaminated water, such as in a polluted harbor or canal.
- The inlet thru hull/seacock is open

For a purge using the freshwater flush

- The vessel's pressurized water system is on
- The grey flush valve is open (horizontal)

Flush Valve



2. Turn on Feed Pump A and check to make sure water is coming out of the brine discharge (thru-hull above water).

3. Run the system without pressure for 60 minutes to purge the storage chemicals. The pressure gauge should read less than 35 PSI. If purging with freshwater the sampling tube may discharge water.

4. Close the pressure relief valve. Turn on Pump B. The pressure should rise to 80-100 PSI. If pressure does not rise Feed Pump A may need to be turned on and off in order to prime both pumps. Water should begin to flow out of the sampling tube. If the ship is located in brackish or fresh water the pressure will be lower.

Depending on storage and environmental conditions the system may need to have additional purging time. If the product water does not taste pure or sample below 500 ppm, purge or run the system for up to 6 additional hours.

New System Startup - Cont.

5. The system may be run with only one feed pump at a time or with both pumps simultaneously. Water quality may improve slightly when running with both pumps, as product salinity decreases with higher feed pressure.

In cold temperatures it may be necessary to run just one pump to reduce system pressure, as colder water will increase operating pressure. Do not operate the system with feed pressures above 125 PSI (8.6 Bar).

Over the course of regular use you will balance the service life of the pumps, production quantity, and energy consumption when deciding when to run the system, and whether to run one or both pumps. When running just one pump, it doesn't matter whether you run feed pump A or B.

*Pressure relief valve open 1/2 turn

Nominal Parameters

System	AMPS				Feed Pressure		Static * Pressure	Feed Flow				Product Flow				Watts/Gallon	
	12V	MAX	24V	MAX	PSI	bar		Flow		MIN	MIN	Flow	Flow	MIN	MIN	Nom	Max
							PSI	GPM	LPM	GP M	LP M	GPH	LPH	GPH	LPH		
Both Pumps	≈ 19	20	≈ 10	11	90-100	6.3-7	30-35	2.8	10.6	2.7	10.2	15	56.7	14.3	54.1	16	18.4
Single Pump	≈ 9	10	≈ 4.5	5	60-80	4.2-5.6	20-25	1.7	6.4	1.6	6.0	8.7	32.9	8	30.2	13	16.5

For Spec Production:

12V Systems: Run at 13.2 VDC min

24V Systems Run at 26.4 VDC min

Testing with an Artificial Ocean

If it is not possible to test run the system with the boat in the water, testing may be accomplished with an artificial ocean. You will need 1.3 lbs. of non-iodized salt (rock salt, sea salt, or aquarium salt) to make 5 gallons (605 grams of salt per 20 liters) of seawater that is about 33,000 PPM salinity (average seawater salinity). A good rule of thumb is 1/2 cup (.12 liters) of salt per gallon (4 liters) of water. Make sure the domestic water system is powered up and the boat's tank has at least 30 gallons (120 Liters) of water to purge the storage chemicals from the system. Confirm that the charcoal filter is installed, and the domestic water line is connected.

1. **Open the pressure relief valve on the Clark Pump half a turn. Remove the green tag and spacer!**
2. Turn the yellow service valve on feed pump module A to OFF.
3. Open the grey flush valve on the charcoal filter housing on feed pump module A.
4. Start a feed pump (Flip metal toggle switch to ON, located on the top right corner of feed pump module A). Let feed pump run for 60 minutes to purge the storage chemicals.
5. Stop the feed pump (metal toggle switch to OFF).
6. Connect the inlet service hose to the service port on feed pump module A, then connect the brine discharge service hose to the quick disconnect on Clark Pump. Refer to the photos below. Route both hoses into a 5 gallon (20 Liter) bucket. Turn product sample valve to the sample position and route the product water into the bucket.
7. Open the grey flush valve and turn on the feed pump until the container is filled with fresh water. Stop the pump and close the grey flush valve.
8. Turn the yellow valve on feed pump module A to SERVICE.
9. Mix the salt to the proper proportion or use an aquarium hydrometer to adjust the specific gravity to 1.025.
10. Start the feed pump, allow to prime, then close the pressure relief valve on the Clark Pump. The system should build pressure and make water by drawing the salt water from the bucket and returning it as brine and product.
11. Run the system under pressure and check for proper operation and leaks.

After testing the system stop the feed pump. Remove the inlet service hose and replace the brine discharge hose. Turn yellow service valve to RUN. Perform a fresh water flush (next page). A fresh water flush will hold the system for 5 days. If you don't use the system in 5 days we recommend the storage procedures.

Valves in flush position:

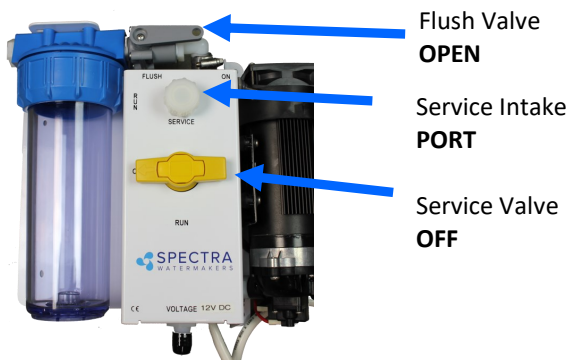

Open the pressure relief valve
On Clark Pump 1/2 turn:



Valves in service position:

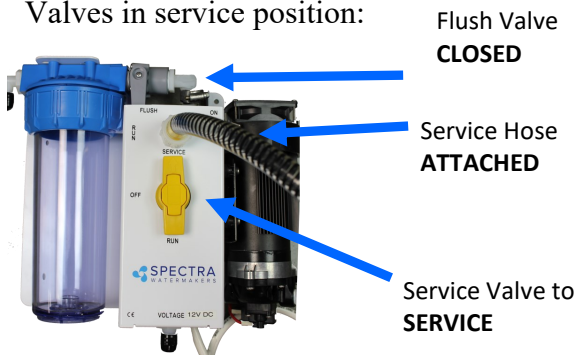

Connect the brine discharge service hose:



Normal Operation and Fresh Water Flush

If the system has been pickled, stored, or contains cleaning compounds, use the New System Startup.

1. Make sure the inlet thru-hull is open.
2. Turn the product sample valve to the SAMPLE position.
3. Turn yellow service valve on feed pump module A to RUN.
4. Start the feed pump (metal toggle switch on feed pump module to ON) and check for flow by inspecting the brine discharge or checking for pressure on your analogue gauge. If there is no flow open the pressure relief valve on the Clark Pump and bleed the air out of the feed pumps by running them **one at a time**.
5. Close the pressure relief valve. After 5 minutes check the product water with your hand held salinity tester. When it is below 750 PPM, divert the product into your tank by rotating the product sample valve handle 90 degrees.
6. Run the system until you have filled your tank or made enough to meet your requirements.

Product Sample Valve



Analogue Gauge Panel



Fresh Water Flush

1. Turn the yellow service valve to OFF. Open the grey flush valve on filter housing at top of feed pump module A. If have the optional Z-ION, flip the switch from Idle/Ready to Run for the duration of your flush cycle.
2. Flush for **your calibrated optimal flush duration (default is three minutes, see calibration instructions)**, alternating between pumps to circulate fresh water through the entire system. Pressure will drop on the gauge, which indicates that the membrane is flooded with fresh water. Stop the feed pumps.
3. Return the yellow service valve to RUN. Close the grey flush valve. If you have the optional Z-ION, turn it back to Idle/Ready. If you forget, the Z-ION will timeout after 15 minutes of runtime to protect the probes.

You may now leave the system unattended for up to five days (30 days with the Z-Ion) without further attention

Remember that you need to run the system almost a half an hour to make enough water for a fresh water flush. You may notice that the system output is higher while charging your batteries as the machine is voltage sensitive.

Feed pump module with valves in the "Run" Position:



Feed pump module with valves in the "Flush" Position:



Optimizing the Fresh Water Flush Duration

Three minutes is usually the right flush duration to ensure that sea water is thoroughly flushed out of the water maker using the least amount of fresh water. However, due to different lengths of hose runs, different rates of flow, and different pressures in shipboard fresh water systems, the flush duration can be optimized for your boat: Your system may require more than three minutes to adequately flush the system, or you might need less time, allowing you to save more fresh water.

Optimize the time

Ideally the salinity of the brine discharge will be completely fresh just as the flush cycle is completed. Using the brine discharge service hose, direct the brine discharge into a bucket. While the system is fresh water flushing, take repeated samples from the brine discharge and test it with a handheld salinity meter. When the PPM drops below 1000 you can consider the system to have been fresh water flushed, and note the elapsed time. This will be your optimum flush duration going forward.

Maintenance, Storage, and Troubleshooting

Cape Horn Extreme 330 Plumbing Diagram

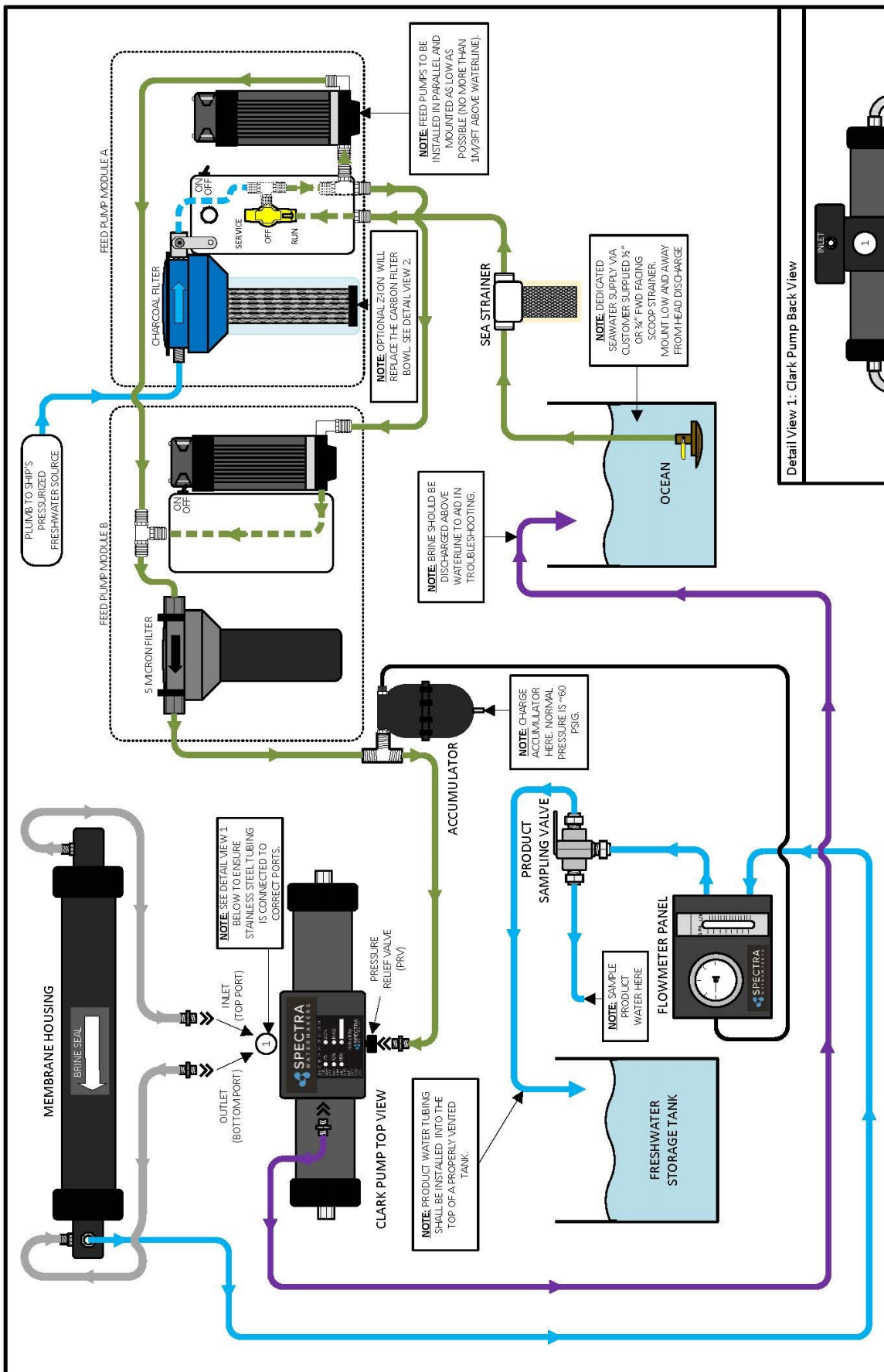

KEY: LIST OF SYMBOLS

SYMBOL	DESCRIPTION
	BLACK 1/4" VINYL
	5/8" CLEAR BRAIDED VINYL
	5/8" CLEAR BRAIDED VINYL
	5/8" CLEAR BRAIDED VINYL
	BLACK 1/4" VINYL
	STAINLESS STEEL TUBING

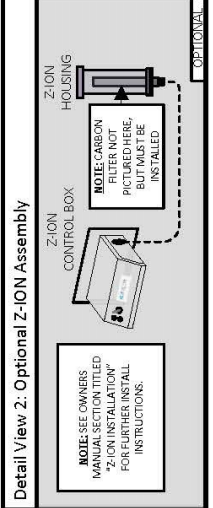

Detail View 1: Clark Pump Back View

INLET
1
OUTLET

Rev. No.	Date:	Description:
A	01/04/2023	Initial Plumbing Diagram for Cape Horn Extreme 330 System.

Revision History:

Capo Horn Extreme 330
Revision: A
Rev Date: 02/10/2023
Print Date: 02/10/2023
Drawn by: JDM
Katadyn Desalination

Suggested Spares

Short term cruising, weekends, etc.:

We suggest two treatments worth of preservative chemicals (either 2 bags of SC-1 or 2 gallons (8 liters) of Propylene Glycol). Six 5-micron filters and one Carbon filter.

Cruising 2 to 6 months at a time:

Twelve 5-micron filters, 2 Carbon filters, enough preservative chemicals for 4 treatments, one replacement feed pump head.



CAUTION: Longer than 6 months:

Additional filters, Offshore Cruising Kit consisting of Clark Pump seals, O-rings, tools, and membrane cleaning chemicals. One replacement strainer screen, O-ring for strainer screen, O-rings for filter housings. Additional feed pump heads and/or feed pump diaphragms.

Common Parts

SC-1 STORAGE CHEMICAL
SC-2 CLEANER
SC-3 CLEANER
BASIC CRUISE A
OFFSHORE REBUILD KIT
5 MICRON FILTER
CHARCOAL FILTER
5" STRAINER SCREEN
OIL/WATER FILTER
FEED PUMP
FEED PUMP HEAD
FEED PUMP DIAPHRAGM
5" STRAINER O-RING
FILTER HOUSING O-RING
CHARCOAL FILTER HOUSING O-RING

Part Number

KIT-CHEM-SC1
KIT-CHEM-SC2
KIT-CHEM-SC3
KIT-BCK-A
KIT-OFFSH
FT-FTC-5
FT-FTC-CC
FT-STN-5S
FT-FTC-OW
EL-FP-12V or 24V
PL-PMP-SFPH
EL-FP-DP
SO-STN-5SS
SO-FHS-10H
SO-FHS-3PCS10

All sales are made through Spectra's network of dealers/full service providers. Contact your local full service provider for additional suggestions and support.

Maintenance

General

Periodically inspect the entire system for leakage and chafing. Repair any leaks as soon as you find them. Some crystal formation around the Clark Pump blocks is normal. Wipe down any salt encrusted areas with a damp cloth.

Watermakers are at their best when run regularly. Biological fouling in the membrane is more likely when a watermaker sits idle. A warm environment will cause more growth than a cold environment. A fresh water flush every five days will greatly reduce biological growth but may not stop it completely. You can also protect your watermaker with the optional Z-Brane or Z-Ion systems: Both protect the membrane from bio-fouling without the use of storage chemicals.



DANGER/ATTENTION: For maintenance, always disconnect from power source first.

The Seawater Strainer

The seawater strainer's stainless steel element should be inspected, removed, and cleaned as needed.



ATTENTION: Ensure that the thru-hull is closed before disassembly and the gasket is in place before reassembly. When the system is put into storage, remove the strainer, rinse with fresh water, and reassemble dry to impede corrosion. Check frequently during operation.

The Prefilter

Service the prefilter on a regular basis. If the system is installed as shown on the plumbing schematic, the pressure will fall on the remote gauge as the prefilter becomes dirty. Extremely dirty filters will harm system performance and may cause the feed pump to cut out from high pressure. Leaving dirty filters in the machine during long idle periods will cause biological contamination. **Please review prefilter bulletin to page 46. prior to running your system.**



NOTE: Prefilter elements must be changed frequently. The rate is solely dependent on the input water. A 5-micron filter might last you a 4-6 weeks in clear open ocean seawater, or be ruined in minutes in a dirty harbor. Spectra does not advise to attempt to clean dirty prefilters. Prefilters are a consumable item and should be changed for new when in question.

To service the filter close the thru-hull, open the prefilter housing, remove the old filter, clean out the housing bowl, and reassemble the housing with a new 5 micron filter element. Leave dry until next startup.



NOTE: Use only Spectra-approved filters or you may void your warranty. Occasionally, lightly lubricate the O-rings with silicone grease.

Maintenance - Cont.

Oil Water Separator (Optional)

For oil/water separation, install the additional filter housing with its oil removal filter *upstream* of the 5 micron filter. Service at the same time as the 5 micron filter.

The Charcoal Fresh Water Flush Filter

Replace the charcoal filter element at least every 6 months. This filter protects the membrane by removing chlorine from the flush water. Use only a Spectra-approved replacement.

The Feed Pumps and Clark Pump

The feed pumps and the Clark Pump require no routine maintenance except inspection for leaks. Tighten any hose clamps or fittings that show signs of leakage. The high pressure fittings threaded into the Clark Pump have O-ring seals with a straight thread. These should never leak and should never be over-tightened. If one of the tube nuts starts to leak, it can be unthreaded, sealed with a bit of silicone grease or oil, and tightened with two wrenches very tightly.

The Membrane

Always perform a flow test before cleaning your membrane. Cleaning with chemicals shortens the lifespan of membranes, so only clean if you are certain it is warranted. The leading cause of fouling is biological growth that forms when the system is left unused without flushing or pickling. Fouling from mineral scaling can happen during operation under certain seawater conditions, and from rust. Monitor the product salinity and feed pressure for higher than normal readings, and take environmental conditions into consideration:

- Cold feed water or clogged filters can cause high pressure.
- Low product flow is usually due to low voltage, a worn feed pump, or a worn Clark Pump.

Test to see if biological growth has occurred: Before running the system, remove the prefilter and examine its condition. If the filter housing is full of smelly, discolored water, the system was not properly stored. Install a clean prefilter.

Next, check the membrane. Attach the brine discharge service hose and lead it into a bucket. Open the pressure relief valve half a turn, and manually run the system for 30 seconds (metal toggle switch on feed pump module). Examine the brine water: If it is discolored and smells bad, perform an SC-2 cleaning with unchlorinated water before running the system pressurized. If the brine is fairly clean, follow the New System Startup procedure and run normally. Check for performance. Clean the membranes **only if** performance is reduced.



NOTE: See the **Cleaning Procedure (pg. 39)** for complete instructions.

Introduction to Spectra Chemicals

We use four types of chemicals: SC-1, SC-2, SC-3, and propylene glycol antifreeze. SC-1 and propylene glycol are for system storage, while SC-2 and SC-3 are for membrane cleaning.



CAUTION: Do not use metasodium-bisulfate, citric acid, or any other storage chemical not supplied by Spectra. These chemicals, used to store other watermaker brands, are very acidic and will damage the Clark Pump and void the warranty.



CAUTION: Never use any chemicals with the system pressurized! Always open the pressure relief valve 1/2 turn. Always follow the instructions for purging the chemicals as shown in the New System Startup section.

Storage

SC-1 prevents biological growth when your system is idle. It should not be used as a cleaning chemical, nor will it protect your system from freezing. A jar of SC-1 is mixed with 1 to 3 gallons of product or dechlorinated fresh water in a bucket and circulated through the system for 10 minutes. This treatment will protect the system for six months, after which the SC-1 treatment must be repeated. To use SC-1, follow the instructions for **Storage Procedure**.

Spectra systems should be stored with propylene glycol if freezing is likely to occur. Propylene glycol can be used instead of Spectra SC-1 storage chemical for storage in any climate, and treatment is effective for one year. Propylene glycol is a food-grade antifreeze used to winterize RV's, boats, and cabins. Do not use ethylene glycol automotive antifreeze, which is toxic and will damage the system.

The propylene glycol formulations sold in marine and RV stores are usually diluted with water. The water remaining in the watermaker before the storage procedure will further dilute the antifreeze, reducing the microbial protection and increasing the temperature at which the mixture will freeze.

Antifreeze labeled "Minus Fifty" is a 25% solution and will begin to form an icy slush at about 15°F (-10°C) and will only provide burst protection to about 0°F (-18°C). After a further 50% percent dilution by water remaining in the watermaker, "Minus Fifty" antifreeze will only protect from bursting down to about 25°F (-4°C). Therefore if low temperature freezing protection is required a 60% or stronger antifreeze should be used. 60% solutions are labeled "Minus 100" and will provide burst protection to -15°F (-27°C) even after a fifty percent dilution with residual water. "Minus 200" formulations are pure propylene glycol.

Introduction to Spectra Chemicals - Cont.

Complete microbial preservative protection requires a 25% solution of propylene glycol, so care must be taken that the solution remaining in the watermaker during long term storage is at least 25%, even if freeze protection is not required. **For these reasons Spectra recommends that all pickling be carried out with a 60% or greater concentration.**



NOTE: See **Winterizing with Propylene Glycol on page 38.**

Propylene glycol can be difficult to flush from a membrane, especially after extended storage periods. This results in high salinity water (high PPM) and residual flavor in the product water. We recommend flushing the system **WITH THE PRESSURE RELIEF VALVE OPEN** for 4-6 hours after storage with propylene glycol—the longer the better. If, after extended flushing, you still experience low product water quality, cleaning with SC-2 usually removes all traces of propylene glycol and returns the salinity to the level it was before storage with propylene glycol. See the **Cleaning Procedure on page 39.**

Cleaners

Cleaning can be detrimental to the membrane and shorten its life. Avoid unnecessary cleaning, and avoid cleaning as a diagnostic tool.

SC-2 is an alkaline cleaner used to remove light oil, grime, and biological growth. It is most effective if heated to 120°F (49°C), which is difficult on a boat. In most cases the water quality will increase in PPM (salinity) after an SC-2 cleaning. After a few hours it should recover to near the level it produced before the cleaning.

SC-3 is an acid cleaner used to remove mineral and scale deposits. In most cases this is used first and if there is no improvement, go on to the SC-2. SC-3 will in most cases lower the product PPM and overall pressures. Scaling is a slow process that may take several months or years. SC-3 is less harmful to the membrane and will almost always improve the performance of an older membrane.

For cleaning with either SC-2 or SC-3, see the **Membrane Cleaning Procedure on page 39.**

Storage Procedure



NOTE: When storing with SC-1 you only need to use one feed pump to circulate the storage solution through the watermaker, but you should briefly alternate pumps to ensure that the SC-1 solution is circulated throughout the system. The watermaker will contain about 2 gallons (8 liters) of water, so starting with one gallon (4 liters) in the bucket there will be about 3 gallons (12 liters) of solution.



CAUTION: Make sure the pressure relief valve on the Clark pump is Open (unpressurized), 1/2 turn counterclockwise OR THE MEMBRANE WILL BE DAMAGED.

1. Perform a fresh water flush. Turn off the feed pump and close the grey fresh water flush valve. Leave the yellow service valve OFF.
2. Disconnect the brine discharge hose from the Clark Pump, and replace with the brine service hose from your service kit. Lead the brine service hose into a bucket.
3. Do another fresh water flush and run the feed pump until you have one gallon (4 liters) of fresh water in the bucket. Turn off the feed pump and close the grey fresh water flush valve.
4. Mix one container of SC-1 storage compound with the water in the bucket. It will not dissolve completely, which is normal, and any particles will be caught by the filter.
5. Connect the intake service hose to the service port on feed pump module A and lead the hose into the solution in the bucket. Turn the yellow service valve to SERVICE. The system will now draw the solution from the bucket and return it via the brine discharge service hose.
6. Turn on a feed pump and circulate the storage chemical through the system for approximately 10 minutes, alternating feed pumps. Turn off the feed pumps.

Clean Up:

1. Remove the brine discharge service hose, and replace the brine discharge hose leading to the thru-hull.
2. Turn the yellow service valve back to RUN, and remove the intake service hose.
3. Close the seacock, drain and clean the sea strainer and prefilter. Reassemble dry with a new filter. Your system is now protected for the next **six months**.

Opening the pressure relief valve:



Connecting brine discharge service hose:

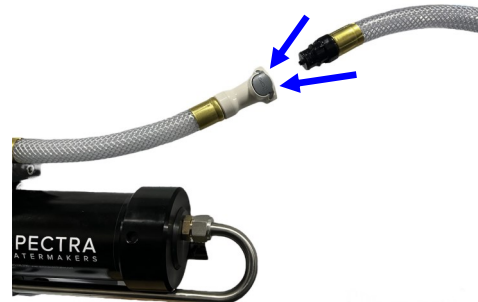

Valves in **SERVICE** position:



Feed pump module valves in **FLUSH** position:

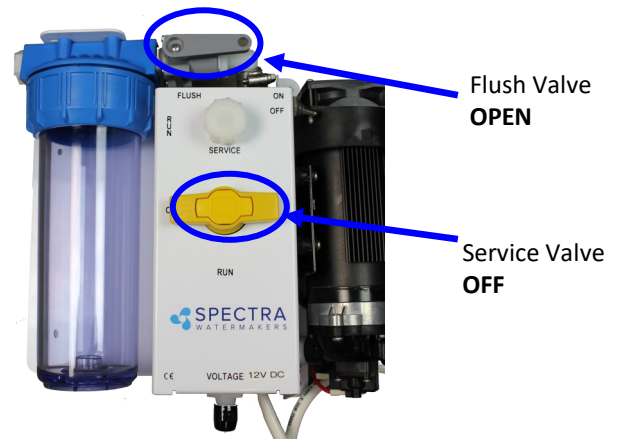

Winterizing with Propylene Glycol



CAUTION: Use only potable water antifreeze (Propylene Glycol).

Do not use automotive antifreeze (Ethylene Glycol).

Propylene Glycol is an effective biocide and antifreeze. Purchase the strongest antifreeze available. See **Introduction to Spectra Chemicals** on page 35 for additional details.

1. Fresh water flush the watermaker. Turn off the feed pumps. Close the grey flush valve (located on feed pump module A).
2. Connect the inlet service hose to the service intake on feed pump module A, and lead it into a bucket. Turn the yellow service valve to the SERVICE position.
3. Connect the brine discharge service hose to the quick disconnect on the side of the Clark Pump and lead it into a second container.
4. Pour 1 gallon (4L) of propylene glycol of appropriate concentration into the bucket with the intake service hose. (See Introduction to Spectra Chemicals for discussion of propylene glycol concentration on page 36)
5. **CAUTION: Make sure that the pressure relief valve on the Clark Pump is OPEN a 1/2 turn, OR THE MEMBRANE WILL BE DAMAGED.**
6. Turn on one of the feed pumps until about a gallon of water has flowed from the brine discharge, or propylene glycol appears. Propylene glycol will look slightly different, and feel more slippery, than water. Stop the pump. Add more antifreeze to the intake bucket if necessary.
7. Lead the brine discharge service hose into the bucket of propylene glycol. The system will now draw propylene glycol from the bucket and return it via the brine discharge hose.
8. Circulate the antifreeze in this manner for about 10 minutes, alternating feed pumps.
9. Stop the feed pumps. Reconnect the brine discharge hose that leads to thru-hull. Run the feed pump until the bucket is empty.
10. Close the seawater intake. Turn yellow service valve to OFF. Drain the seawater strainer and the hose leading to the feed pump modules. Disconnect the product tubing from the membrane housing and blow residual water out of the tubing. Empty the charcoal filter housing and flush water lines.



Your watermaker is now protected from biological growth and freezing for one year.

Opening the pressure relief valve:



Connecting brine discharge service hose:

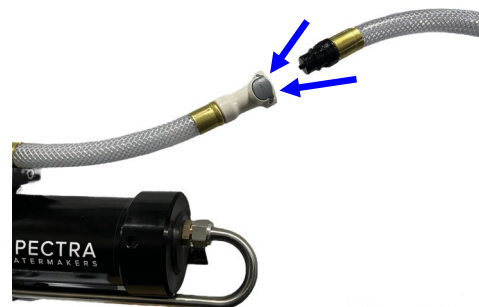

Valves in **SERVICE** position:



Feed pump module valves in **FLUSH** position:

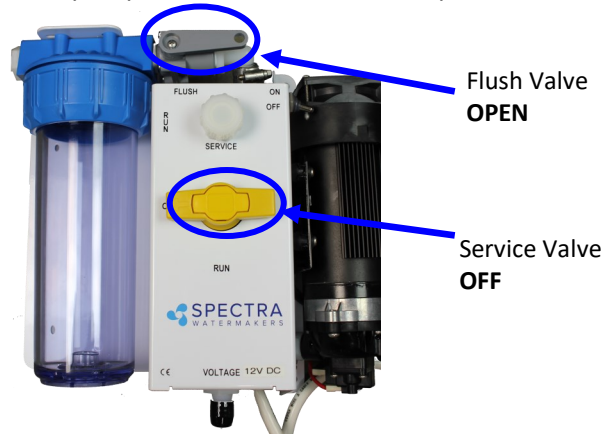

Membrane Cleaning Procedures



NOTE: Procedures are the same for the SC-2 and SC-3 cleaners

A Spectra cleaning compound (SC-2 or SC-3) must be mixed with fresh water at a ratio of 1 container of compound to 3 gallons (12L) of unchlorinated fresh water. **An average of two gallons (8 liters) of water is already present inside a Cape Horn Xtreme system**, and this water must be figured into the mixture. Warm water is ideal for cleaning membranes: Use a large stainless steel pot to heat the solution to 120°F(49°C). You might have to periodically stop and reheat the solution.

1. Perform a fresh water flush. Stop the feed pumps and close the grey flush valve.
2. Connect the inlet service hose to the service intake on the feed pump module A. Connect the brine discharge service hose to the quick disconnect on the Clark Pump. Lead the hoses into a bucket. Open the grey flush valve and run feed pump A until you have 1 gallon (4 liters) of water in the bucket.
3. Turn off the feed pump and close the grey fresh water flush valve.
4. Turn the yellow service valve on feed pump module A to SERVICE.
5. **CAUTION: Make sure the pressure relief valve on the Clark Pump is OPEN 1/2 a turn (system is unpressurized) OR THE MEMBRANE WILL BE DAMAGED.**
6. Mix the cleaning chemical with the water in the bucket.
7. Start feed pump A and circulate the chemical through the system for 45 minutes, if the solution is warm. Let the solution sit in the unit overnight if the cleaning solution is cold.
8. Stop the pump, replace the brine discharge hose, and run the pump until the bucket is empty. Stop the feed pump and turn the yellow service valve to RUN. Follow the instructions for a New System Startup.



CAUTION: KEEP PRESSURE RELIEF VALVE OPEN to flush out the cleaning chemicals.

Feed Pump Module Valves in **flush position:**



Opening the pressure relief valve On Clark Pump:



Valves in **service position:**

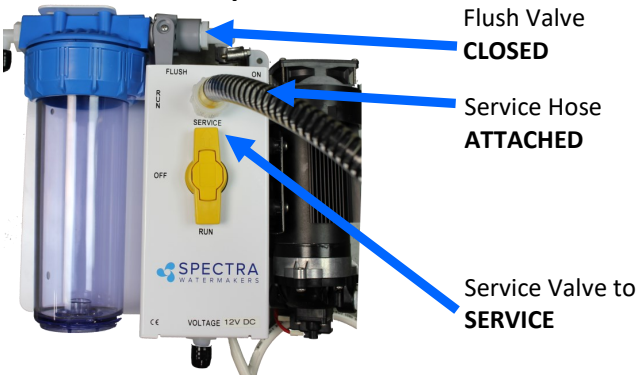

Connecting brine discharge service hose:

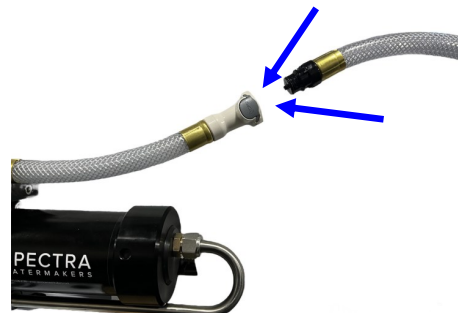

Flow Test for Dual ShurFlo Pumps (Cape Horn Extreme)



NOTE: The flow test is the most useful diagnostic test for system performance, and should be done before replacing or cleaning your membrane. Changes in production or water quality are normally caused by something **other than** the membrane, unless the system has been left unused for a long time.

Before the flow test, change the prefilter and clean the sea strainer. Carefully check for water or air leaks, as air in the system will cause low production and erratic salinity. Look for air bubbles in the product flow meter, feed water hoses, and brine overboard hose.

Run the system and watch the pressures very closely. If the feed pressure to the Clark Pump is asymmetrical from one stroke to another, this could be part of the problem. **A difference of a few PSI is acceptable, but anything over that is an issue.** If the pump is asymmetrical, Clark Pump repairs should be done before continuing with these tests.

If no asymmetry is noted, continue with this test.

You will need a graduated bucket, either a graduated pitcher or large measuring cup, and a stopwatch. Before the flow test, change all filters and clean the sea strainer. Carefully check for water or air leaks, as air in the system will cause low production and erratic salinity. Observe the feed pressure and ensure that the Clark Pump cycles symmetrically. Log the voltage at the feed pumps at the same time. Confirm at least 12.5 Volts at the feed pump on 12-Volt DC systems; 25 volts on 24-Volt DC systems.

Take two measurements and compare them with the table in the New System Startup section. The first measurement is the product flow alone. The second is the product flow combined with the brine discharge flow to get the total flow or feed flow. You may take these measurements by two methods:

1. Time the product flow into a graduated pitcher, then divert both the product flow and brine discharge together into a bucket to measure total flow.

OR

2. Divert the product flow into the pitcher while diverting the brine discharge into the bucket. Time the flow of both. After calculating the product flow, pour the pitcher of product into the bucket of brine to measure total flow.

The ratio of product flow to total flow gives us the recovery rate, expressed as a percentage. If the percentage is below the minimum it indicates an internal leak in the Clark Pump.

Flow Test - Cont.

On the Cape Horn Xtreme, you should perform the tests using each pump alone, then using both pumps. Compare the results to the table in the New System Startup section.

1. Product flow: Product flow is expressed in Gallons Per Hour (GPH) or Liters Per Hour (LPH), by this equation:

$3600 \div \text{time in seconds} \times \text{quantity of water in gallons or liters} = \text{GPH or LPH}$
There are 3600 seconds in an hour.

Example: It took 3 minutes and 35 seconds to collect 1 gallon of product water.
 $3600 \div 215 \times 1 = \mathbf{16.74 \text{ GPH}}$ (3 minutes, 35 seconds is 215 seconds)

Example: It took 2 minutes and 25 seconds to collect 2.5 liters of product water.
 $3600 \div 145 \times 2.5 = \mathbf{62.07 \text{ LPH}}$ (2 minutes, 25 seconds is 145 seconds)

2. Total Flow or Feed Flow: Feed flow or total flow (brine + product) is expressed in Gallons Per Minute (GPM) or Liters Per Minute (LPM), by this equation:

$60 \div \text{time in seconds} \times \text{quantity of water in gallons or liters} = \text{GPM or LPM}$

Example: It took 1 minute and thirty-seven seconds to collect 5 gallons of total flow.
 $60 \div 97 \times 5 = \mathbf{3.09 \text{ GPM}}$ (1 minute, 37 seconds is 97 seconds)

Example: It took 53 seconds to collect 12 liters of total flow.
 $60 \div 53 \times 12 = \mathbf{13.58 \text{ LPM}}$

3. Recovery Rate: Product Flow \div Total Flow = Recovery Rate %

Example: $\frac{6.5 \text{ GPH product flow}}{1.7 \text{ GPM total flow} \times 60} = \mathbf{.063 \text{ or } 6.3\%}$

(you must first multiply total flow by 60 to convert from GPM to GPH)

In order to make good water, you need the proper amount of feed water flow. Each pump alone should produce 1.5 gallons per minute (5.7 LPM) of brine discharge PLUS product water. Running on both pumps the flow should be 2.7 GPM (10 LPM).

Compare the product flow to the total feed flow. Product flow should be between 8% and 9% of total flow for a Cape Horn Xtreme. If product percentage is low, you may have an internal leak in the Clark Pump and it probably needs to be rebuilt.

For every $\frac{1}{10}$ th of a GPM feed water flow loss, we will lose about $\frac{1}{2}$ gallon (1.89 liter) per hour of product flow and the salinity will go up 100 PPM.

Low feed flow combined with low system pressures is most frequently due to worn Shurflo pump heads (PL-PMP-SFPH).

Troubleshooting Cape Horn Extreme Systems

SYMPTOMS	PROBABLE CAUSE	REMEDY
Low product flow, more than 1 GPH, Total flow down (See Flow Test.)	Motor receiving less than 12.5VDC. A 0.5 VDC decrease at the feed pump motor can equate to a loss of 0.5 gallons (1.89 liters) product per hour. If possible, run diagnostic tests when the system is getting at least 13.2 VDC.	Check for voltage drop. Increase wire size if necessary.
		Check Power Supply.
		If available, turn on battery chargers.
	Blockage or restriction in the system.	Replace prefilter, service strainer, and check all hose runs.
	Thru-hull blockage	Confirm by using intake service hose and bucket of seawater to bypass thru-hull Clean thru-hull.
	Mineral scaling	Perform SC-3 Cleaning. <i>Note: By design, it is rare for the membrane to cause low total flow on Spectra Systems.</i>
	Pump or Motor worn	Confirm by attempting pressure test (See Tech Bulletin). Strong pumps with good power should reach 125 psi within 3 seconds. Replace pump head.
Low product flow, Recovery percentage below minimum nominal value (See Flow Test)	Pressure Relief Valve open partially	Close pressure relief valve.
	Internal leak in Clark Pump	Complete service is recommended. Contact Dealer or see Clark Pump rebuild manual. Install Offshore Kit.
Asymmetrical pressure and flow readings between pump shifts – When one shift has 0 pressure	Internal leak in Clark Pump.	While system is running kink brine hose to stop flow until feed pressure rises to 115 psi, release hose quickly, repeat no more than 10 times. Inspect Clark Pump Check Valves.
Asymmetrical pressure and flow readings between pump shifts- more than a few psi	Scored Clark Pump annular rings and reversing valve spool	Replace.
	Scored Clark Pump piston rod and lip seals	Confirm by opening test port on back of pump. If constant flow, replace seals and circular sand (240 grit) or replace piston rod.
	Scored Clark Pump Cylinder(s)	Hone, circular sand (240 grit) or replace.



Troubleshooting Cape Horn Extreme Systems

SYMPTOMS	PROBABLE CAUSE	REMEDY
No Product flow, good brine discharge flow. Recovery percentage is 0 (See Flow Test)	Internal leak in Clark Pump.	While system is running kink brine hose to stop flow until feed pressure rises to 115 psi, release hose quickly, repeat no more than 10 times.
		Inspect Clark Pump Check Valves.
		Complete service is recommended. Contact Dealer or see Clark Pump rebuild manual. Install Off-shore Kit.
Feed Pump not running, no noise	No Power At feed pump	Check voltage at feed pump.
	Pressure switch failed.	Adjust or bypass. To bypass, turn off power and pull off the 2 cables with push-on terminals and connect them together with a piece of electrical cable pushed into each terminal. Do not run the pump for long, just to diagnose failure.
Feed pump runs intermittently cycling on/off	Overpressure switch on Feed pump opening	Adjust or replace switch.
Feed Pump runs with loud noise	Intake blocked	Check Through Hull.
	Air in system	Check sea strainer for leaks.
		Check freshwater flush module for leaks.
		Re-prime system (restart).
Feed Pump turns on but no pressure	Feed Pump air locked	Open pressure relief valve to bleed the air then close to start
	Pressure relief valve open	Close pressure relief valve.
Feed Pump Starts but shuts down on high pressure	Prefilter excessively clogged	Change prefilter.
	Closed valve or blockage in flow	Check flow path for closed valve or kink in hose.
High Feed Pressure, High Amperage, and Product flow down up to 15%	Colder or more saline seawater	Normal Condition.
	Brine or product flow observing back pressure	Confirm by running both into a bucket.



Troubleshooting Cape Horn Xtreme Systems

SYMPTOMS	PROBABLE CAUSE	REMEDY
	Scaled or Fouled Membrane	Clean membrane.
Low Feed Pressure, Low Amperage	Warm seawater or brackish water	Normal Condition.
PPM rises steadily while pressure and production remain constant	Membrane needs to be replaced	Consult dealer and replace membrane.
PPM high	TDS meter needs calibration	Re-calibrate TDS meter or taste test water until you are able to replace.
	Feed flow or Clark Pump problem	Low product flow, recovery percentage or feed pressure can lead to drop in product water quality, perform Flow Test and address flow issue.
	Membrane was fouled or damaged	Clean membrane or consult dealer about membrane damage when product flow and pressure are at spec levels but water tastes salty.
	Fouled Prefilters	Freshwater flush procedure needs to be tested and adjusted. Replace filters or run watermaker for an extended period of time to rinse.



Technical Bulletins



NOTE: The following pages include Spectra's most commonly used technical bulletins, addressing tests, adjustments, troubleshooting, and common points of confusion. Many more technical bulletins are available on the Spectra website, support.katadyn.com.

DWYER FLOW METER SERVICE

The mechanical flow meter, PL-FMT-10 (10 GPH range) or PL-FMT-20 (20 GPH range) can be opened for cleaning if it becomes difficult to read or if the little ball gets stuck.

The flow meter will come completely apart for cleaning. First remove the meter from the panel. Remove the four small screws that hold the stainless steel bracket in place. Carefully wedge out the steel bracket. Above where the bracket was removed, there is a clear plastic slide-out. Use a flat bladed screwdriver to pull it out carefully. Once it is out, insert your flathead into the space it was removed from and gently nudge upwards to remove the top piece. Invert the flow meter and catch the ball as it falls out. You can use tooth paste or plastic window polish to polish the inside using a small bottle brush, or simply a q-tip. Clean the ball and give it a few coats of wax. If the O-rings are damaged or the unit has been leaking, install new O-rings using a little silicone grease to ease assembly. These are standard O-rings and should be available at most larger auto parts or bearing stores. Reassemble in reverse.

ACCUMULATOR PRESSURE

Your Spectra watermaker is supplied with a pressure accumulator tank (PL-ACC-TK), which should be installed in the feed water line between the prefilters and the Clark Pump.

The purpose of the feed line accumulator is to reduce the spikes in the feed pressure caused by the cycling of the Clark Pump. If the accumulator is not properly charged it can lead to problems with the Shurflo pump pressure cutout switches.



NOTE: The accumulator has a Schrader air valve, like a car tire, which allows the internal air bladder of the accumulator to be pre-charged. The accumulator should be pumped up to about 65 psi (4.5 bar) for best results. Add air using a tire pump or air compressor. You can experiment with the exact pressure that will give the best pulsation dampening on your installation.

Connections to feed water hose, between Shurflo pump and Clark Pump



PREFILTERS

It is important to remember that your Spectra Watermaker is designed to process clean, open-ocean seawater. Any departure from that standard for your seawater intake runs the risk of causing excessive wear or damage to internal pump parts and/or the vulnerable reverse osmosis membrane. Additional prefiltration considerations and/or extremely frequent prefilter replacements may be required in any deviation from open-ocean seawater. Your local service provider or installer may have specific recommendations based on their experience with water conditions unique to your region.

Observe the seawater around your vessel. Is it clean enough to use for your seawater intake? There are several things to avoid feeding to your watermaker:

- *petroleum products, such as oil, fuel, thinners, paints, paint removers, etc.*
- *chlorine-treated water; e.g., most “dock” water*
- *silty water — water contaminated by fine, hard, suspended particulates*
- *putrid water, “red tides”, or any seawater that smells or looks contaminated*
- *harbor/marina water that you cannot see through or that shows visible signs of contaminate (neighboring boats docked nearby may be discharging contamination! Sewage, chemicals, etc.)*

Judging the quality of seawater input always involves a certain calculated risk. We know of watermaker systems that have been destroyed far offshore by intaking fresh whale excrement or oil contaminants from natural seepages. The chance of such things happening is normally small but should be considered. On the other hand, **regularly running a watermaker in an enclosed marina or harbor runs a much higher risk of harmful contamination.** If you need to test a new installation while in a marina or harbor, monitor the water quality around your vessel carefully while testing. Often times you should be able to run the watermaker safely for enough time to briefly check out the system if you are mindful of external feed conditions. If this is not possible, an artificial ocean is a useful alternative (see Page 26 for artificial ocean testing/instructions). Don't sail away without testing a new installation or repair!



ATTENTION:

A Cape Horn Xtreme system uses two different filters to prevent damaging foreign materials from entering the system. A single 5 micron filter cleans the feed water of abrasive materials while the system is in operation; an additional carbon filter prevents the entrance of chlorine during fresh water flushing.

During normal operation, the feed water is filtered in two stages. First it passes through a fine mesh metal sea strainer, which protects the feed pump from foreign materials and sea creatures. After passing through the feed pump, the feed water passes the filter housing containing 5 micron element, removing very fine particles that could damage the Clark Pump and shorten membrane life.

Replacement schedules will vary widely depending on how and where the system is used. If large amounts of feed water are run through the system over a relatively short period of time in biologically fertile near-shore waters, the prefilter will plug up, water production and quality will drop, and the system pressure will change dramatically. If the pressure gauge was installed after the prefilters, as pictured on the plumbing schematic, the pressure will decrease as the filter becomes more clogged.

PREFILTERS CONT.

When operated for only an hour or two a day in inland or near-shore waters, the trapped plankton will begin to decay in the filter long before it plugs up. The decaying plankton and bacteria will cause a rotten egg smell in the product water. This decay will set in overnight in tropical waters, or after a week or two in higher latitudes. In crystal clear blue water conditions, the filters may need to be cleaned much less frequently.

If handled gently and changed regularly before they get too smelly, filters can be cleaned and reused several times.

Our filter element part number is FT-FTC-XX. The last digits indicate the micron rating, e.g. FT-FTC-5 is for a 5 micron element:



CHARCOAL FILTERS



ATTENTION:

The charcoal filter element (FT-FTC-CC) removes chlorine from the fresh water flush water supply. The RO membrane can only handle small amounts of chlorine without permanent damage. If the fresh water flush water contains chlorine, the membrane will be exposed to it for days and will produce high salinity water.

The charcoal filter used for the fresh water flush system will not plug up unless you have very dirty domestic water in your boat's supply tank. About six months after installation the charcoal filter element will lose its effectiveness and must be replaced. This is purely a function of time.

The charcoal filter we supply removes 99.7% of the chlorine. Beware when buying other charcoal filters. If they don't specify the percentage of chlorine removed, don't use them. Cheap ones may remove only 60% or 70%. Also, there are aftermarket filters which are very close to, but not exactly the same dimensions, and will not seal properly in the housing. If you skimp on the charcoal filter you risk damaging a \$600.00 membrane on the first flush. The other factor is the flow rate that the filter can handle. Because the chlorine is adsorbed by the charcoal, it must remain in contact with the charcoal for a sufficient period of time for the all of the chlorine molecules to be captured. The filters we use can handle 1.5 gallons (6 liters) per minute flow, and are good for 3000 gallons (12,000 liters) at 1.5 GPM, or six months, whichever comes first. Regardless of the flow, the charcoal loses its effectiveness after six months.



Charcoal filter, Spectra part number FT-FTC-CC

SHURFLO PUMP WON'T RUN

If the pump has power to it but the pump won't run, first check the pressure switch. The pressure switch (EL-FP-PS) is located on the wet end of the pump and has two red wires plugged into it.



DANGER: Jump the two red wires together and see if the pump runs. You can safely run the system with the pressure switch jumped, just keep an eye on the pressure gauge and don't let system pressure exceed 110 PSI. Replace the switch when a spare is available. The pressure switch should never open unless there is a problem with the system or it is incorrectly adjusted. Check the accumulator pressure, the operating feed pressure, and the switch cut-out setting.

If the pump will not run with the pressure switch jumped then it is most likely a problem with the brushes or overheat protection switch inside the motor. The motor will come completely apart by removing the two screws on the end of the motor. Remove the rear cover and paper insulator. Pull out the plastic brush holder. The thermal switch is located on one of the brush leads. With an ohmmeter, check for continuity through the switch. If it is open, you can make temporary repairs by wiring around it, being careful that your new wiring doesn't chafe on the moving parts, nor resist the springs that push the brushes on to the commutator. The overheat switch is unlikely to fail unless the motor has overheated and shut down. Consider relocating the pump or improving ventilation if the overheat protection has failed.

If any corrosion is apparent the brushes may be sticking. Once apart clean all the carbon dust from all the parts. Clean the commutator with light sandpaper. Make sure to clean the small grooves on the commutator with a small sharp tool to remove the carbon in between the segments. Adjust the springs on the brush holders so the brushes slide smoothly in and out. If the bearings are rough and binding, remove the rubber dust cover and clean the best you can, grease them, and work them free by hand. Don't service the bearing unless absolutely necessary. Reassemble in reverse order. You can hold the carbon brushes back with papers clips inserted through the slots in the brush holder so they don't hang up on the bearing during assembly. Make sure the corrugated bearing shim doesn't push out, if it does, push it back into place.

ADJUST SHURFLO PRESSURE SWITCH

Shurflo feed pumps are equipped with a high pressure cutout switch (EL-FP-PS). This is the small black unit on the end of the wet end of the pump head (PL-PMP-SFPH) where the two red wires connect. If the pressure switch is not properly adjusted the pump may cut out each time the Clark pump cycles and the feed pressure spikes. When this happens the production will drop and salinity will increase. The points in the switch will fail quickly if set too low because of the constant arcing each time the Clark Pump shifts.

On the very center of the switch is a small 5/64" Allen screw. While running the system close the brine discharge seacock or kink the discharge hose, to block the flow. Watch the pressure gauge and adjust the pressure switch to shut off at 125 psi. Turn the Allen screw clockwise to increase the cut off set point.



Poor Product Water Quality

With any product water quality issue, you must ensure accurate calibration if you are using a salinity meter. For general quality evaluation, your taste is always good enough.

Membranes are not an exact science and two identical systems can have different product quality. World health standards deem water of up to 1000 PPM of total dissolved solids acceptable for drinking consumption. We consider any thing below 750 PPM acceptable but not ideal, and anything below 500 PPM excellent. Factors that could affect water quality are addressed below.

LOW SYSTEM FLOW OR PRESSURE will equate to lower product quality (higher PPM).

Cape Horn Xtreme systems will produce slightly better quality water running two pumps, as this will create higher pressure and lower salinity. Worn feed pump heads or flow restrictions will cause lower feed pressure and higher salinity.

DAMAGE TO THE MEMBRANE by chlorine contamination. Flushing the system with chlorinated water will irreparably damage the membrane. Charcoal filters are used to absorb any chlorine which might be present in flush water. They must be of proper specification to be suitable. There is no test for chlorine damage except the process of elimination of other causes.



DANGER:

DIRTY OR SCALED membranes. A dirty (foreign material), scaled (mineral deposits), or contaminated (bacterial growth) membrane can result in poor water quality and abnormal operating pressures. If operating pressures are above normal, then cleaning is indicated. If the system pressures are within operating normal range, cleaning may have little result. Avoid cleaning as a diagnostic tool. Low water quality after storage with propylene glycol can usually be remedied by extended flushing or an SC-2 cleaning.

MECHANICAL LEAKAGE within the membrane pressure vessel. This is an unlikely but possible cause of poor water quality. A pinched or damaged O-ring within the pressure vessel, a scratch on the product tube on the membrane, a scratch within one of the end caps, or a seal fouled by contamination could allow sea water into the product water.



NOTE: *If system flow (product plus brine) is 2.7 GPM or above (1.6 GPM running one feed pump), the membrane is clean, the product flows are consistent with the system flow and the water quality is still not acceptable, then replacement of the membrane is indicated.*

Cape Horn Extreme Part Numbers

Feed Pump Module A, with charcoal filter for fresh water flushes

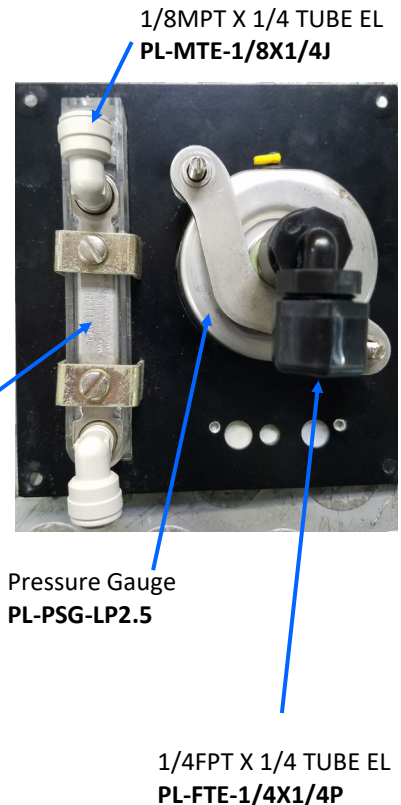
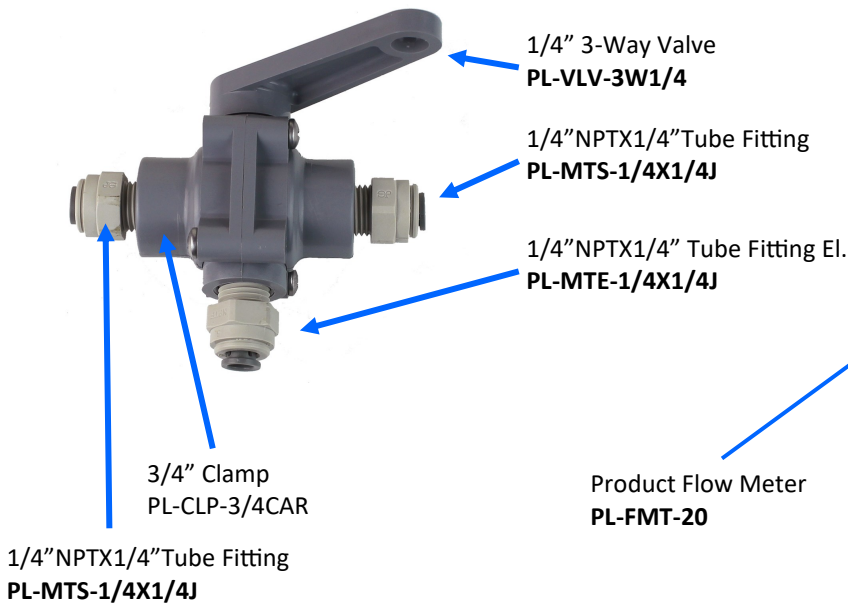
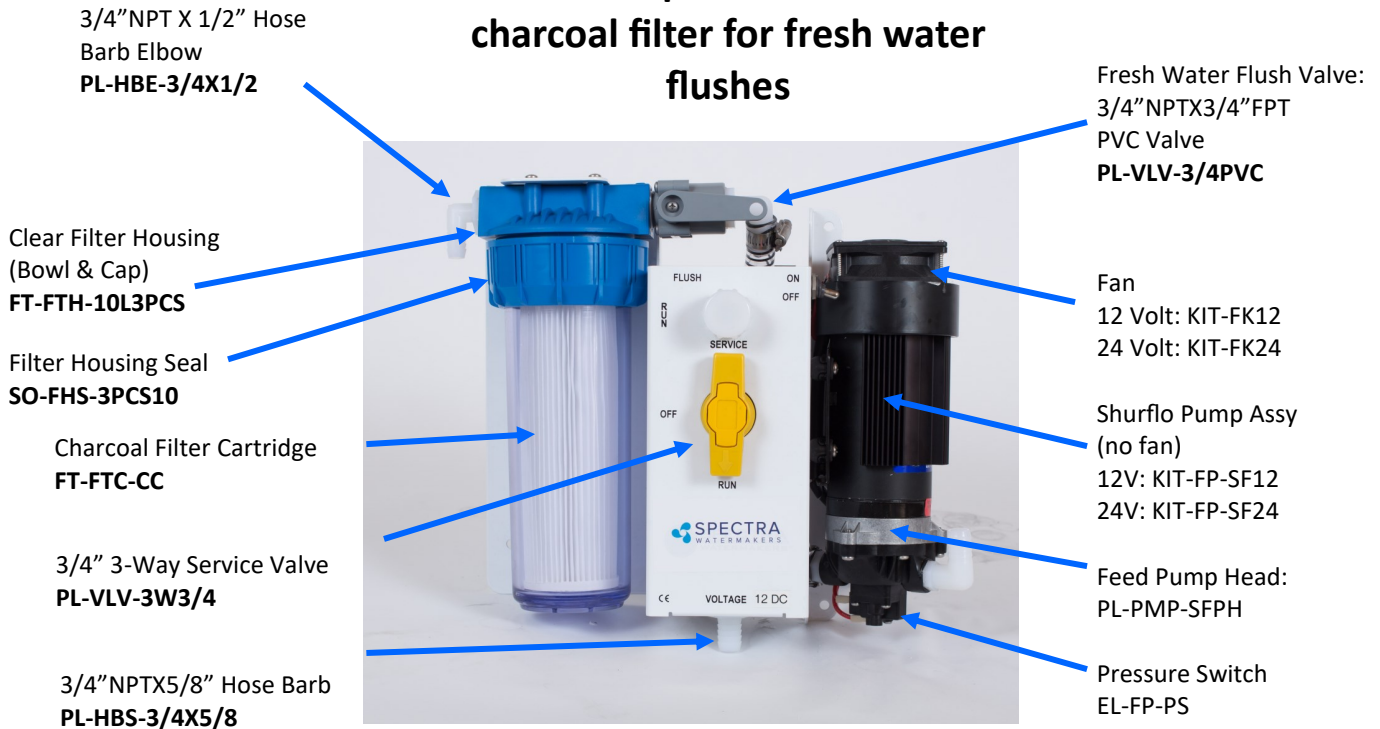

Cape Horn Extreme Part Numbers - Cont.

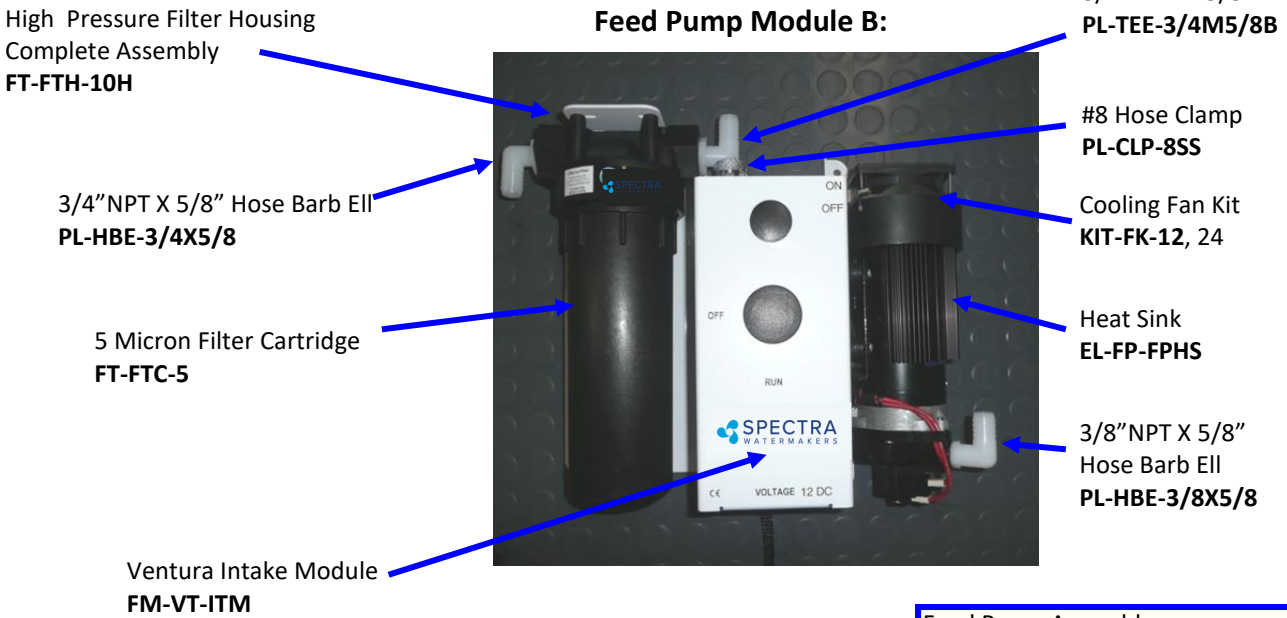
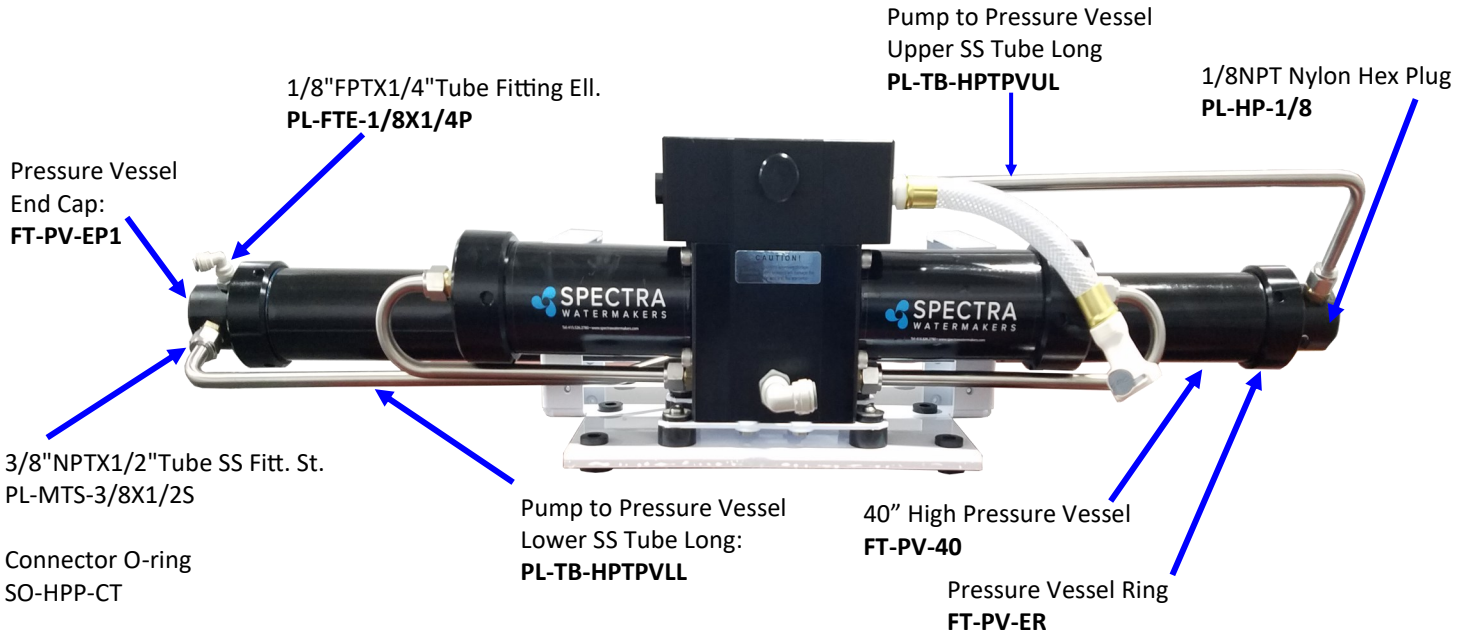

**Feed Pump Assembly
(Complete Pump With Heat Sink)
KIT-FP-SF12 or 24**

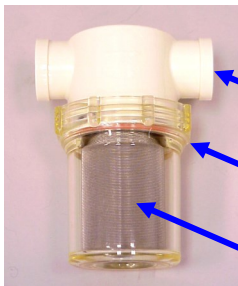

**Sea Strainer (Complete Assembly)
FT-STN-5**

Strainer Seal **SO-STN-5SS**

Strainer Screen **FT-STN-5S**

Pump Head Assembly With Pressure Switch **PL-PMP-SFPH**

Pressure Switch **EL-FP-PS**

Shurflo Pressure Switch **KIT-FP-SFSK**

Cape Horn Extreme Part Numbers - Cont.

3/8" NPT Quick Disc. Coupling Body
PL-QDC-BD3/8

5/8" Quick Disc. Fitting Hose Barb
PL-QDC-HB5/8

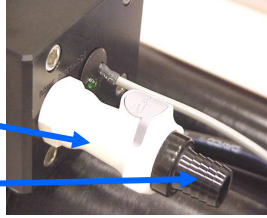

Accumulator Tank
PL-ACC-TK

1/2" X 1/4" Bushing Reducer
PL-BSH-1/2X1/4N

1/2" NPT X 5/8
 Hose Barb
PL-HBS-1/2X5/8

1/2" Nipple
PL-NP-1/2N

1/2" Female Tee
PL-TEE-1/2FN

Pump to Pressure Vessel
 Lower SS Tube:
PL-TB-HPTPVLL

1/4 MPT X 1/4 TUBE
 Straight Fitting
PL-MTE-1/4X1/4

Nickel-Bronze High
 Pressure Straight Fitting
SUB-MTS-3/8X1/2

3/4"-16 Straight Thread
 O-RING
SO-FT-STF

Pump to Pressure Vessel
 Upper SS Tube:
PL-TB-HPTPVUL

Nickel-Bronze High Pressure Elbow
PL-MTE-3/4S1/2B

Plate Bracket End Cap
FM-PVB-PBE

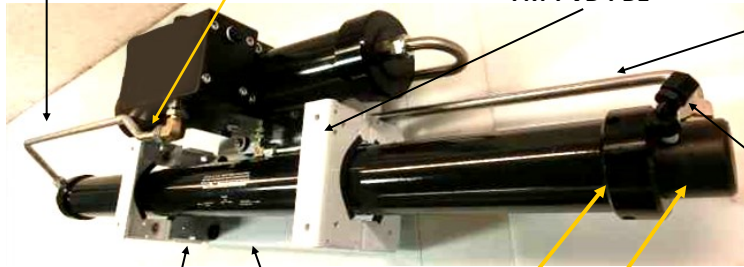

Rear View

Plate Bracket
FM-PVB-PB

Pressure Vessel End Cap
FT-PV-EP

Rubber Mount
HD-RBP-RM
 Plastic Spacer
HD-SPN-MKINS

Pressure Vessel End Ring
FT-PV-ER

1/2" Stainless Ferrule
PL-HWR-1/2FR

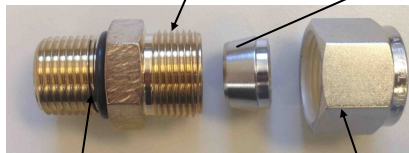

Connector O-RING
SO-HPP-CT

Stainless Fitting Hex Nut
PL-HWR-1/2HN

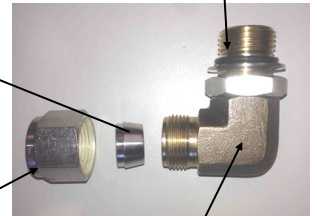

Nickel-bronze high pres-
 sure 90 degree fitting
PL-MTE-3/4S1/2B

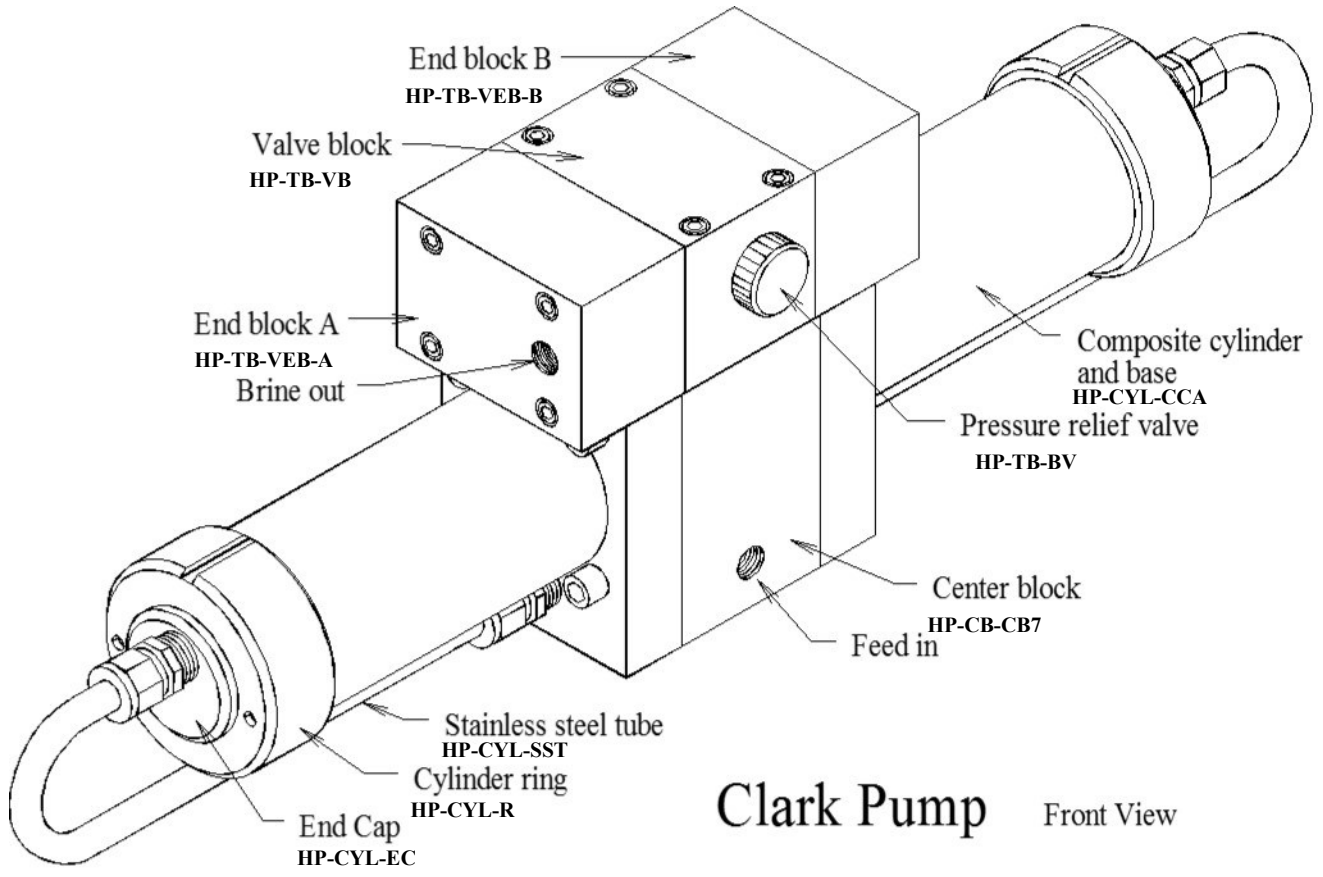

Clark Pump Front View

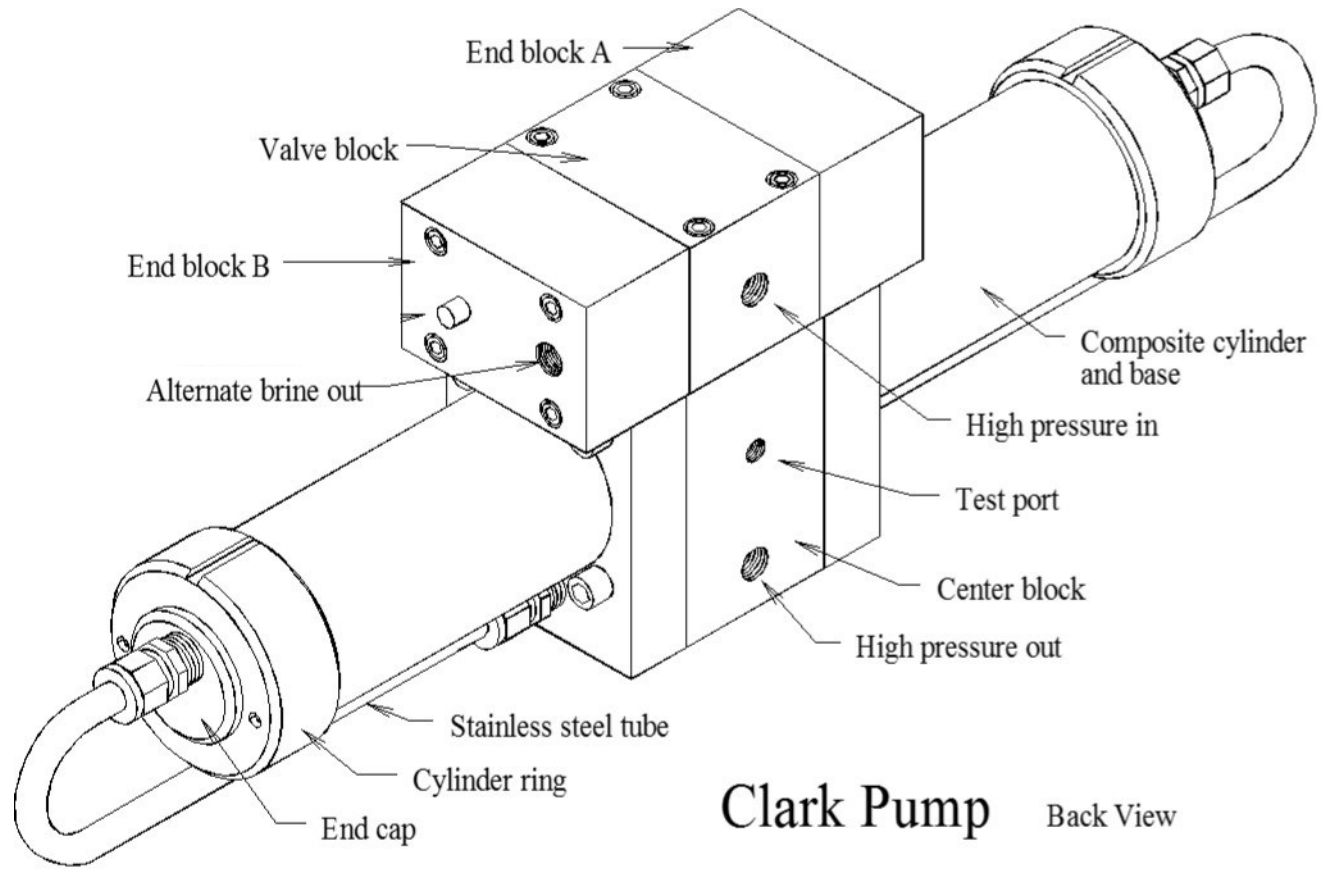

Clark Pump Back View

Spool Assembly
Exploded View

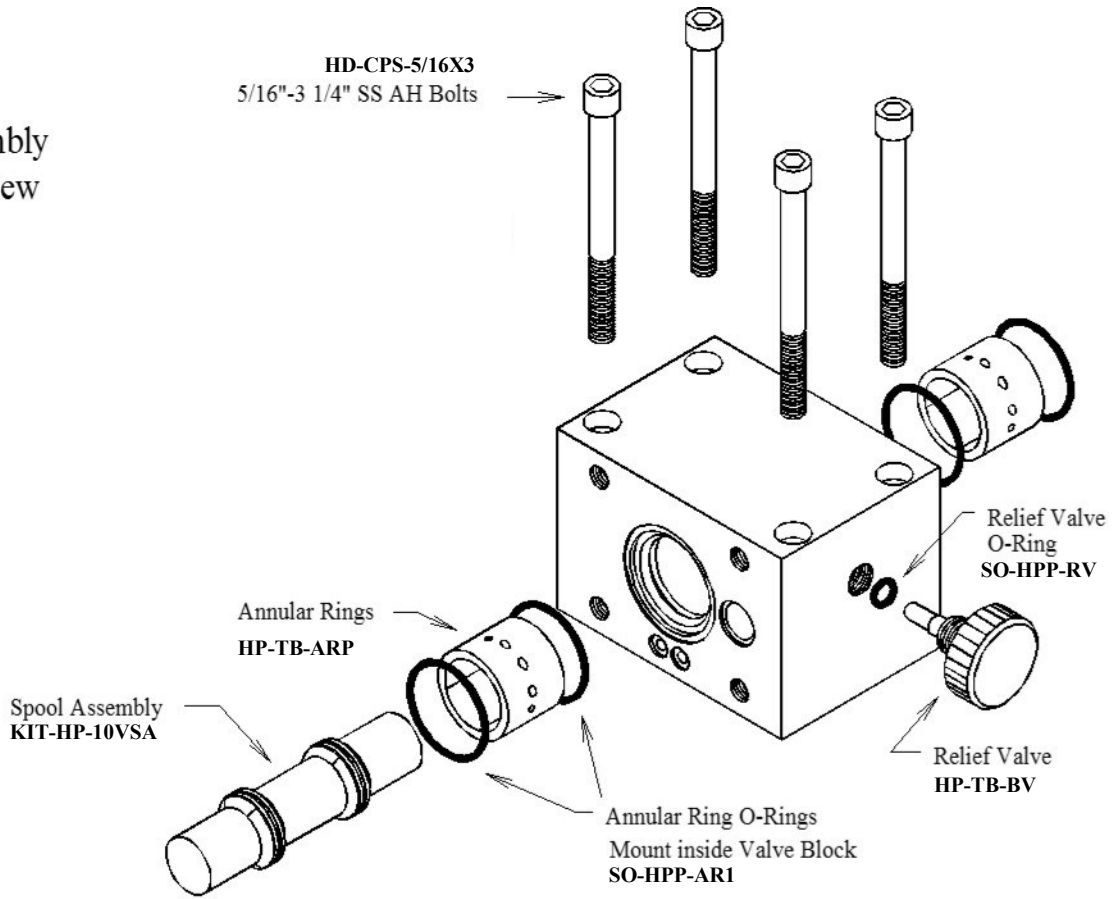

Valve Block

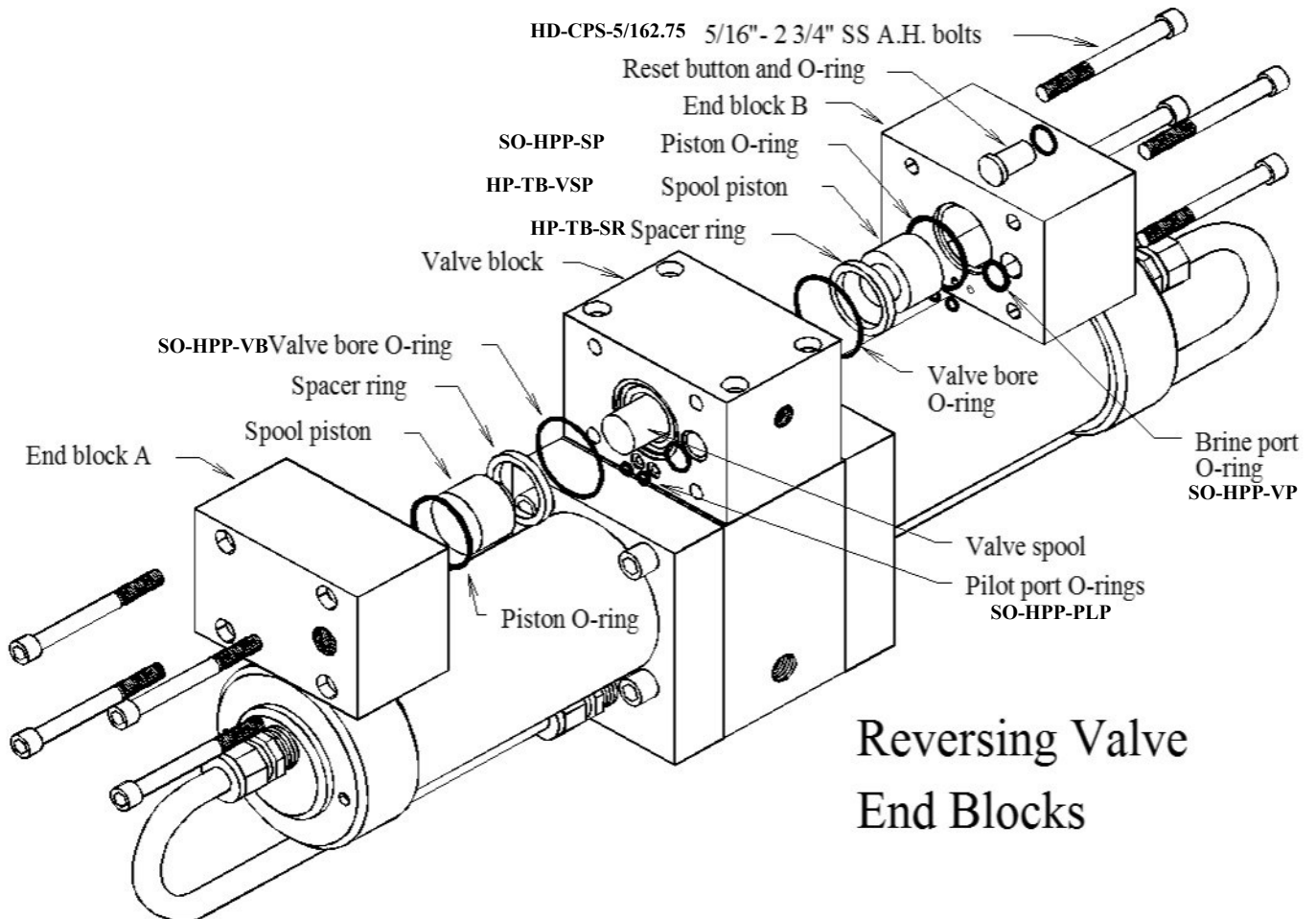

Reversing Valve
End Blocks

Parts

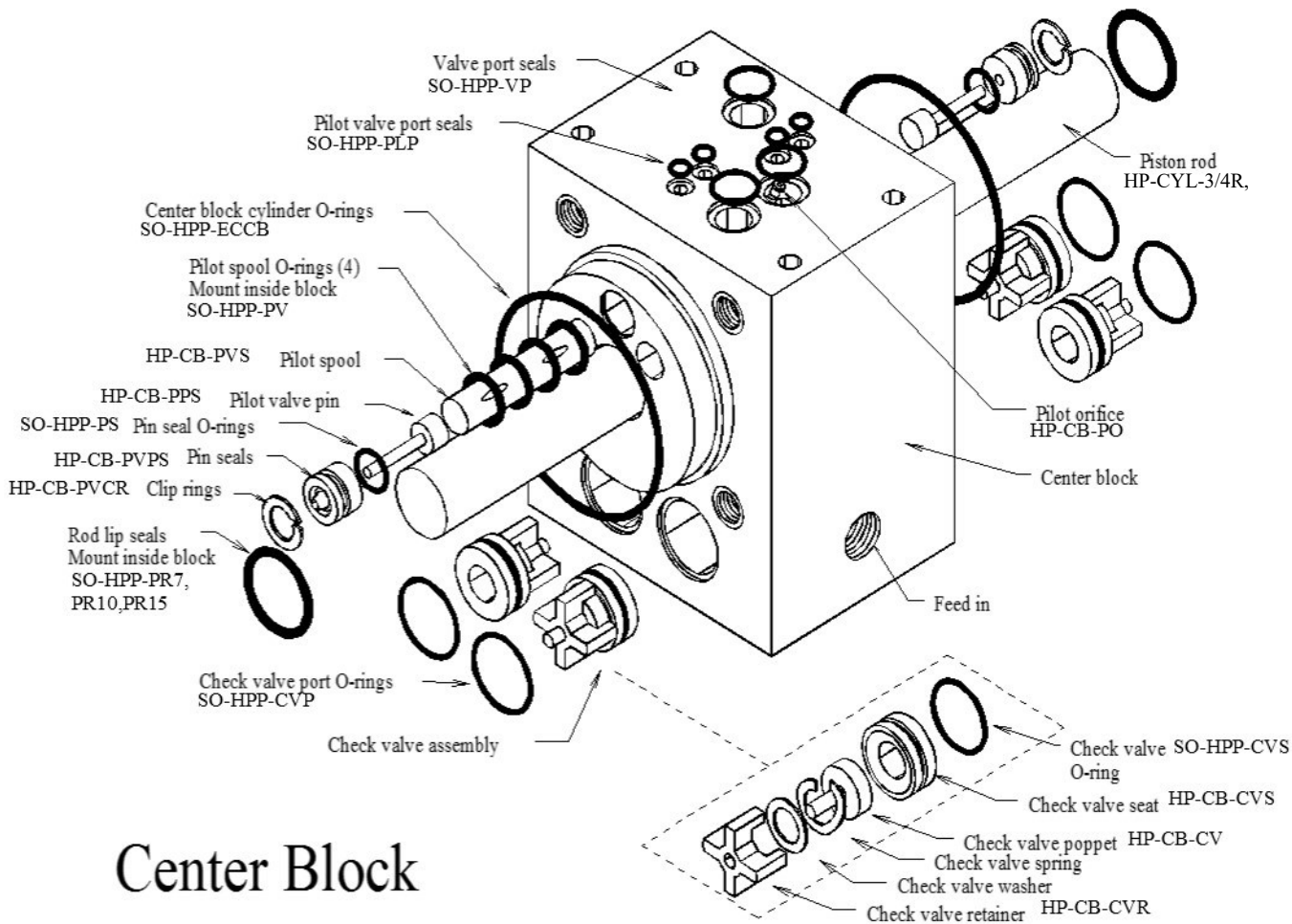

Center Block

Parts

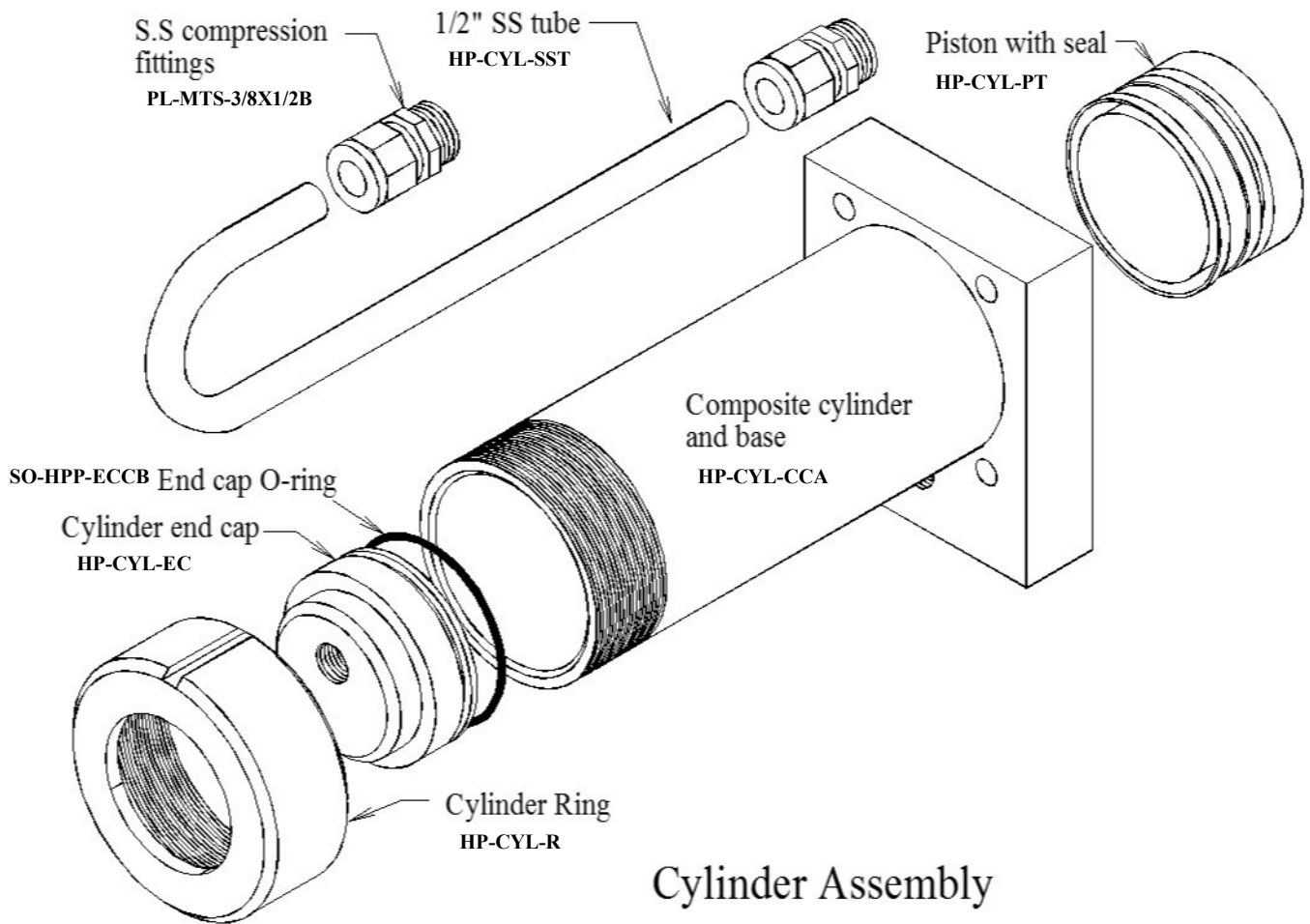

Owner Resources & Warranty

EXCITING EXTENDED WARRANTY OFFER!

-Upgrade the standard 1-YEAR manufacturer warranty to 2-YEARS and LIFETIME on Clark Pump.

Follow the below steps to submit for approval:

- 1. Have system installed & commissioned by Spectra Authorized FSP (full-service provider)**
- 2. Fill out web-based Product Registration form (see back of owner's manual for paper copy)**
- 3. Complete web-based install/commissioning form (see back of owner's manual for paper copy)**
- 4. Upon satisfactory review of required submissions, your 4-digit system serial number will receive an extra year of warranty coverage, and lifetime coverage on the Clark Pump!**

See 'Extended Warranty' section of owner's manual for full coverage details.

Spectra Product Registration Form

(To be completed by end user/owner)



https://spectrawarranty.formstack.com/forms/product_registration

Spectra Watermakers Commissioning Report

(To be completed by authorized installer)



https://spectrawarranty.formstack.com/forms/spectra_install_commissioning_report

Note: Offer & warranty criteria effective 1/1/2021. For purchases made in the EU, please see 'Expanded Warranty' section of warranty policy in back of the manual for EU specific coverage.

Spectra Watermakers. Making fresh water worldwide.

Spectra Watermakers is a Katadyn Group Brand.

KATADYN GROUP
SWITZERLAND

SPECTRA WATERMAKERS

SPECTRA WATERMAKERS LIMITED LIFETIME WARRANTY

THIS LIMITED WARRANTY APPLIES TO THE ORIGINAL OWNER OF THE WATERMAKER AND IS NOT TRANSFERRABLE

For warranty information regarding products sold within the European Union please contact [eu-
rope@spectrawatermakers.com](mailto:eu-
rope@spectrawatermakers.com).

This limited product warranty is provided by Katadyn Desalination LLC, a Business Unit of the Katadyn Group. (“Manufacturer” of “We” or “Our”) to the original, consumer owner of the product (“You” or “Your”) with which this limited product warranty is provided (the “Product.”)

The Manufacturer warrants to You that the product will be free from defects in material and workmanship under normal use and regular service and maintenance, subject to the exclusions described below, for a period of 1 year (the “Warranty Period”) after date of installation, or 15 months after the shipment date, whichever comes first. This warranty will be extended for an additional 12-month period when the product is installed and commissioned by a Katadyn Desalination Authorized Installer. A Spectra Watermakers Commissioning Report must also be returned and approved by the factory. The Spectra Clark Pump has a Limited Lifetime Warranty on Marine systems to the original consumer owner of the product, not inclusive of repair or replacement parts due to wear over time. If the Spectra Clark Pump is used in a Landbased application, the product warranty is provided for a period of 1 year (the “Warranty Period”) after date of purchase (if purchaser is installing system) or date of commissioning (if Spectra dealer is installing system).

You will be required to show written documentation supporting the date of purchase or date of commissioning. If you are unable to provide documentation supporting the date of purchase or commissioning, the warranty period shall be based on the product’s date code and will be determined by the Manufacturer’s sole and absolute discretion.

WHAT IS COVERED

Katadyn Desalination LLC. warrants, for the period defined above, that the Product will be free from defects in materials and/or workmanship and will conform to Manufacturers published specifications if installed and maintained in accordance with the Manufacturers Instructions.

WHAT IS NOT COVERED

The Warranty does not include service, repair, or replacement to correct damage caused by improper installation, maintenance, improper connection with water systems, external electrical fault, accident, alteration, misuse, abuse, neglect, negligence, (other than Manufacturer’s), acts of God, failure to install or maintain the product in accordance with the Manufacturers instructions.

DAMAGED OR MISSING PRODUCT

You must examine the Product upon receipt and notify Katadyn Desalination LLC. if any item is damaged or missing within 30 days from the date of the delivery. Damage due to freight must be reported to Katadyn Desalination LLC. and to the freight carrier within 24 hours of delivery.

SOLE WARRANTY

THE WARRANTIES SET FORTH IN THIS SECTION ARE THE SOLE AND EXCLUSIVE WARRANTIES GIVEN BY THE MANUFACTURER WITH RESPECT TO THE PRODUCTS AND ARE IN LIEU OF AND EXCLUDE ALL OTHER WARRANTIES, EXPRESS OR IMPLIED, ARISING BY OPERATION OF LAW OR OTHERWISE, INCLUDING WITHOUT LIMITATION, MERCHANTABILITY AND FITNESS FOR A PARTICULAR PURPOSE WHETHER OR NOT THE PURPOSE OR USE HAS BEEN DISCLOSED TO MANUFACTURER IN SPECIFICATIONS, DRAWINGS OR OTHERWISE, AND WHETHER OR NOT MANUFACTURER'S PRODUCTS ARE SPECIFICALLY DESIGNED AND/OR MANUFACTURED BY MANUFACTURER FOR YOUR USE OR PURPOSE.

WHAT WE WILL DO TO CORRECT PROBLEMS

If You return the defective product during the warranty period and in accordance with the instructions contained herein, shipping prepaid, the Manufacturer shall, at its option and as Your exclusive remedy, repair, correct or replace the product at no charge if the product is found by the Manufacturer to be a valid warranty claim, in Manufacturer's sole discretion. Replacement product may be refurbished and/or different models but will be functionally equivalent to the product or hardware being replaced. Product repaired or replaced during the warranty period shall be covered by the foregoing warranty for the remainder of the original warranty period or ninety (90) days from the date of shipment or purchase, whichever is longer. Contact your Dealer or the Manufacturer's Customer Service at 415-526-2780 to obtain a returns materials authorization (RMA #).

HOW TO MAKE A WARRANTY CLAIM

If You discover any warranty related issues after 30 days, or You have questions concerning Your product or how to determine when service is needed, please contact your local dealer or contact the Manufacturer's Technical Support at 415-526-2780 or email the Manufacturer at techsupport@spectrawatermakers.com. The following information must be provided as part of Your warranty claim: your name, address, phone number, Your products' model number, Your product's 4-digit serial number, and if necessary, upon request, written confirmation of the date shown on Your purchase receipt and the purchase price paid for the product. All products being returned to the Manufacturer must have a return material authorization (RMA) number to be processed. Any item returned to the Manufacturer without an RMA number will not be accepted by the Manufacturer. Contact your Dealer or Customer Service to obtain an RMA number. Once we have received Your returned product, we will determine, in our sole and absolute discretion, whether Your claim is covered by, or excluded from, this limited warranty. Repairs or modifications made to the product by other than the Manufacturer will nullify this limited warranty. Coverage under this limited warranty is conditioned at all times upon the original purchaser's compliance with these required notification and repair procedures.

LIMITATION OF LIABILITY TO THE FULLEST EXTENT PERMITTED BY LAW, IN NO EVENT, SHALL MANUFACTURER OR ITS AUTHORIZED SERVICE REPRESENTATIVES BE LIABLE FOR ANY INCIDENTAL, SPECIAL, INDIRECT, OR CONSEQUENTIAL DAMAGES, INCLUDING ANY ECONOMIC LOSS, WHETHER RESULTING FROM NONPERFORMANCE, USE, MISUSE OR INABILITY TO USE THE PRODUCT OR THE MANUFACTURER'S OR ITS AUTHORIZED SERVICE REPRESENTATIVE'S NEGLIGENCE. THE MANUFACTURER SHALL NOT BE LIABLE FOR DAMAGES CAUSED BY DELAY IN PERFORMANCE AND, IN NO EVENT, REGARDLESS OF THE FORM OF THE CLAIM OR CAUSE OF ACTION (WHETHER BASED IN CONTRACT, INFRINGEMENT, NEGLIGENCE, STRICT LIABILITY, OTHER TORT OR OTHERWISE), SHALL MANUFACTURER'S LIABILITY TO YOU EXCEED THE PRICE PAID BY THE ORIGINAL OWNER FOR THE MANUFACTURER'S PRODUCT.

The term "consequential" damages shall include, but not be limited to, loss of anticipated profits, business interruption, loss of use or revenue, the cost of capital or loss or damage to property or equipment. Some states do not allow the exclusion or limitation of incidental or consequential damages, so the above limitation may not apply to you. This limited warranty gives you specific legal rights, and you may also have may other rights which vary from State to State.

--- CUT HERE ---

Spectra Product Registration Form

Any commissioning/install report (and additional 12 month warranty) may be rejected at the sole discretion of Spectra Watermakers if the system is not installed correctly.

Registration (To be completed by owner)

System Details:

Model _____ Date of install: _____
 4-digit S/N _____ Clark Pump S/N: _____ Voltage _____
 Dealer/distributor: _____ Boat Location: _____ max speed: _____

Boat model or type (i.e. Leopard 44, Beneteau 55' powerboat, catamaran, powercat, 42' sailboat...)

What type of boating will you be doing and what will the watermaker primarily be used for:

Original Owner Details:

Name: _____ Phone Number: _____
 Email Address: _____
 Address (Optional): _____

Submission for Approval:

Please submit this document along with the Installation and Commissioning Reports to Spectra Watermakers for approval. Submissions can be **submitted online**, scanned and emailed, or mailed directly to the factory. Spectra Watermakers Technical Support will email the original owner and the authorized distributor with the status of submission.

Web-Based Format (Preferred option):

spectrawarranty.formstack.com/forms/product_registration
spectrawarranty.formstack.com/forms/spectra_install_commissioning_report

Email: TechSupport@SpectraWatermakers.com

Phone: +1(415) 526-2780

Address: Katadyn Desalination
 Technical Department
 2220 S. McDowell Blvd Ext
 Petaluma, CA 94954
 USA

Please keep a copy of these reports for your records.

--- CUT HERE ---

Spectra Watermakers Installation Report

(To be completed by authorized installer)

The following checklist is designed to confirm that the watermaker installation meets Spectra standards. Fill out the checklist as completely as possible. Check any boxes that apply and note any concerns. Please document any discrepancies or concerns with photos.

INLET

- Inlet Seacock is below waterline
- Inlet Seacock is dedicated
- Inlet Seacock is shared
- Inlet Thru-Hull forward facing scoop
- Has strainer
- Has diving snorkel
- Sea chest
- Other

Thru Hull Size: _____ IN/CM

Approximate location on vessel and notes: _____

FEED PUMP MODULE A

- Feed pump module is mounted upright
- Clearance for filter cartridge changes
- Intake hoses are free of kinks
- Pressurized domestic water is connected to carbon filter

Distance from waterline: _____ FT/M above /below the waterline

FEED PUMP MODULE B

- Feed pump module is mounted upright
- Clearance for filter cartridge changes
- Intake hoses are free of kinks

Distance from waterline: _____ FT/M above /below the waterline

HIGH PRESSURE MODULE and BRINE DISCHARGE

- Pressure relief valve is accessible
- Brine discharge has no obstructions and vents to atmosphere

Notes: _____

PRODUCT WATER TUBING

- Product water flows into top of freshwater tank
- Freshwater tank is vented

INSTALLATION SIGN OFF

Technician's Name: _____ Date: _____

Technician's Signature: _____

Distributor/Dealer _____

CUT HERE ✂

Spectra Watermakers Commissioning Report – Page 1

(To be completed by authorized installer)

The following checklist is designed to confirm that the watermaker installation meets Spectra standards and that the system is performing at specification.

Fill out the below checks as completely as possible. Check any boxes that apply and note any concerns.

PURGE

- Storage Chemicals have been purged with PRV open

Length of purge: _____ Minutes

- Diversion Valve is up, in reject position
- Filter condition has been calibrated
- "Run Manual" switch engages full speed
- "Service" switch engages flush speed

RUN HIGH MODE CHECKS

Product Flow: _____ GPH/LPH

Confirmed Product Flow Rate _____ GPH/LPH

- Technician Flow meter. Brand _____
- Hand Measurement _____ Gal/Liters in _____ SEC/MIN

Product Quality: _____ PPM

- Confirmed product quality with handheld TDS meter

Feed Pressure: _____ PSI/BAR

Boost Pressure (with clean prefilters): _____ PSI/BAR

Brine Flow Rate: _____ GPM/LPM

Measurement taken with:

- Technician Flow meter. Brand _____
- Hand Measurement: _____ Gal/Liters in _____ SEC/MIN
- Boost Pump runs
- Output and motor speed decrease when low mode is engaged

Notes: _____

FRESHWATER FLUSH

- Freshwater Flush solenoid valve opens
- Feed Pump is not cavitating when system flushes with seacock closed

Ship's pressurized freshwater pump flow & pressure rating _____ GPM/LPM _____ PSI/BAR

When seacock is open, what is the ppm of brine discharge at the end of the flush _____

Flush duration is _____ Minutes

- Needed to change flush time
- Needed to change speed of feed pump during flush

Notes: _____

*If the system does not have a dedicated forward-facing scoop type thru-hull or will be on a vessel that moves faster than 15 knots the system needs to complete the following sea trial checks. Spectra Watermakers reserves the right to require a sea trial from any customer before approving a commissioning report.

SEA TRIAL

- Watermaker will flush while underway
- Watermaker will start while underway

While the vessel is underway moving _____ KNOTS/MPH/KPH the watermaker is producing _____ GPH/LPH at _____ PPM

Spectra Watermakers Commissioning Report – Page 2

OWNER EDUCATION

Owner has been trained on the following:

Know locations of

- Seacock/Thru-hull
- Sea strainer Module
- Feed Pump Modules A and B
- Prefilter
- High Pressure Module
- Clark Pump Pressure Relief Valve
- Product water inlet to Freshwater Tank
- Sampling Tap
- Brine Discharge location
- Service hoses and storage chemicals
- User Manual

- How to power the watermaker off and on at the main breaker.
- How to run the watermaker.
- How to freshwater flush and the importance of freshwater flushing.
- Knows each pump can make water individually.
- Knows when the ships domestic freshwater pump is on.
- Knows which prefilter cartridges to use and how to change them.
- Knows how to service the sea strainer module.
- Knows where the carbon block filter is and is familiar with (6 months) service frequency.
- Have visually seen the overboard brine discharge (Should know when the system is pumping water).
- Knows how to sample the product water.
- Understand when the Clark Pump is under pressure and cycling.
- Have seen how the service hoses and bucket are used to circulate seawater or freshwater through the system.

Notes:

COMMISSIONING REPORT SIGN OFF	
Technician's Name:	_____
Technician's Signature:	_____
Owner's Name	_____
Owner's Signature	_____

