



AQUIFER 200 & 360 EXPEDITION “FLIGHT READY” OWNER’S MANUAL

Instructions also included for the Optional Solar Power Unit



Katadyn Desalination, LLC
Manufacturer of Spectra Watermakers
PH 415.526.2780
FX 415.526.2787
www.spectrawatermakers.com
Revised April 2023

Table of Contents

Introduction	Page Number
Getting Started	4
Hose Connections	6
Solar Power Pack & Universal Voltage kit	8
Well Pump Connections	12
Aquifer Plumbing Diagram	14
Operation	
New Systems Start Up and Testing.....	16
Operation	17
Maintenance.....	23
Service & Maintenance	
Long Term Storage	20
Winterizing	22
Membrane Cleaning	25
Suggested Spares.....	26
Troubleshooting Procedures, Service Bulletins	27
Wiring Diagram.....	29
Fitting details	31
Parts breakdown	35

Getting Started

Unpack the system and inspect it to make sure that it has not been damaged in shipment.

Refer to the shipping list for your system to make sure you have received all of the components listed. Do not discard any packaging until you have found and identified all of the parts. The small installation parts are listed on the kit list. **Warning! We will not be held responsible for shortages and or freight damage that are not reported within thirty days of the ship date.**

Aquifer 200 Expedition Shipping List (One Pelican Case)

- Aquifer Portable Watermaker including one Submersible Well Pump with Hose and Power Cable (25')
- 5/8" Discharge Hose (25')
- 1/4 product tubing (10')

Aquifer 360 Expedition Shipping List (Two Pelican Cases)

- Aquifer Portable Watermaker
- Second Pelican case with two Submersible Well Pumps with Hose and Power Cables (25')
- Pump connector (two pumps into one connector)
- 5/8" Discharge Hose (25')
- 1/4 product tubing (10')

(Optional) Aquifer Solar Power Pack

- Solar Power Pack (in a separate Pelican Case)
- Two solar panels for the AF-200 and three solar panels for the AF-360

Optional Items

- Case of 25 prefilters (fit in the Aquifer 360 pump case as shown in photo below)
- AC power supply (installed in the watermaker box) for units that do not come with the Solar Power Pack



Getting Started Continued...

The Spectra Aquifer Expedition systems come fully assembled and ready for use. All connectors are marked for easy identification. The submersible pumps plug directly into the 24vdc power supply.

Placement Ideally the system should be stored and used in a cool, dry, location within 20' of the feed water source. The system comes with 25' of intake hose attached to each of the submersible well pumps. The case is splash resistant, but not water tight and the unit should be stored with the lid open until any water in the case has evaporated. Choose a location where any water spilled during filter changes will not be a problem. If the unit is to be installed in a mobile vehicle, it should be strapped down to keep it in place.

Feed Water The Aquifer Expedition is designed to be operated up to 20 feet above the waterline.

Brine Discharge Install the female quick disconnect fitting in the brine discharge hose and route it back to the feed source away from the pump(s). If a well is the feed source then discharging on the ground away from the well is advised.

Feed Pressure Gauge
Product Flow Meter



Note: Systems without the Solar Power supply can be ordered with a 100-300vac 50/60 Hz AC power supply installed in the watermaker box.

The Aquifer 200 will only have one 24VDC connector as it has only one feed pump.

Either system will also run on an external 24 vdc power source.



Aquifer Expedition Hose Connections

Watermaker Case

Case for pumps and hoses

Pump storage bags - Use when storing the pumps wet. Not for long term storage.

Pump connector hose - connects directly to the feed pumps .

Brine Discharge - Discharge to a nearby drain site according to local regulations

Feed water hose - connects directly to the feed pump connector.

Note that all hoses are color coded except for the product hose which is clear.

Quick connect fittings

Connection to Options Solar power supply

5 micron filter with gauge

Brine discharge hose

Feed Water connection

Connect to pumps
(AF-200 unit has one pump and the AF-360 has two)

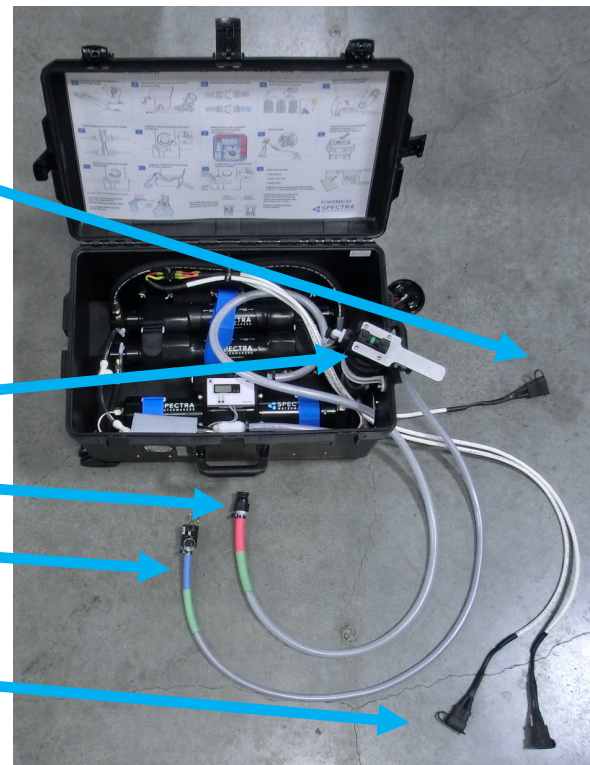
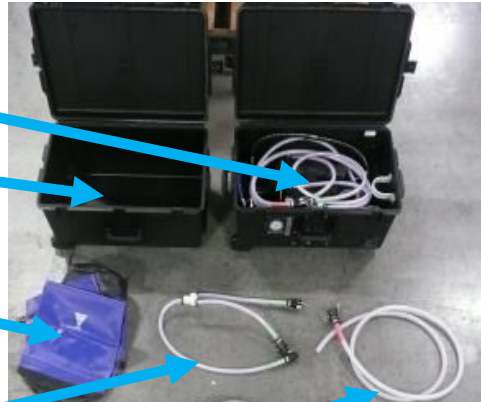

Aquifer Expedition Hose Connections

Product Outlet

Warning!

Pressure in the product tubing must never exceed 5psi (0.3bar) at any time or the membrane will be permanently damaged. The product water should fall into the storage tank through an air gap so there is no back pressure on it. **DO NOT!** feed the product into a manifold or the bottom of a tank. Make sure that there is no possible restriction in the product hose or connections.

Note: The product flow meter displays the flow per hour. In normal operation the flow will go up and down as the Clark Pump Shifts.

It is a good idea to keep a record of the flow rate and system pressure so you understand system performance. This data will inform any future maintenance or service requirements.

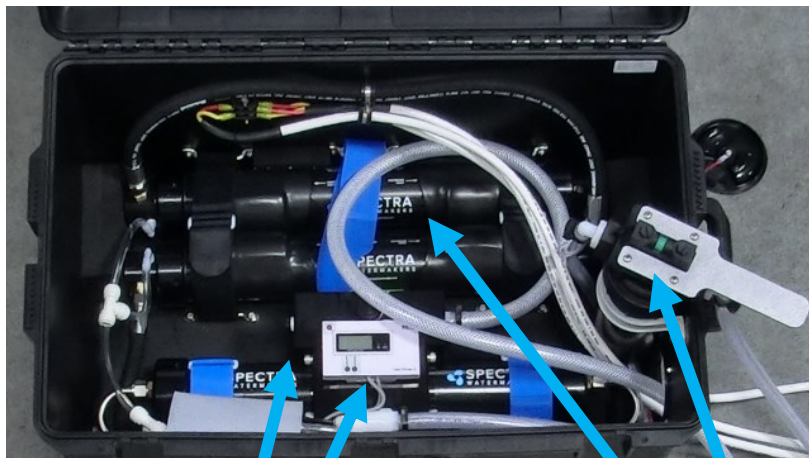

Clark Pump
Salinity Gauge

Prefilter with gauge
Membranes

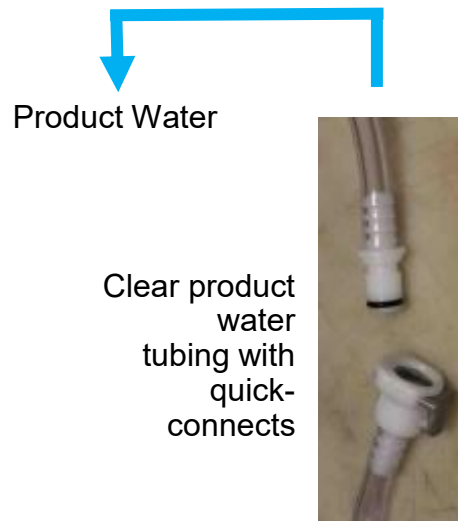

Clear product water tubing with quick-connects

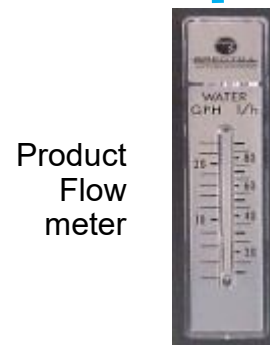

Product Flow meter

Product water from membrane via clear 1/4" hose

Optional Aquifer Expedition Solar Power Pack

This system handles universal voltage inputs and will operate on both AC and DC power sources;

- 100—240 vac 50-60Hz (using a standard US 110vac plug)
- Solar power from the three 145watt solar panels
- 12 vdc to input terminals (jumper cables)
- 24vdc to input terminals (jumper cables)

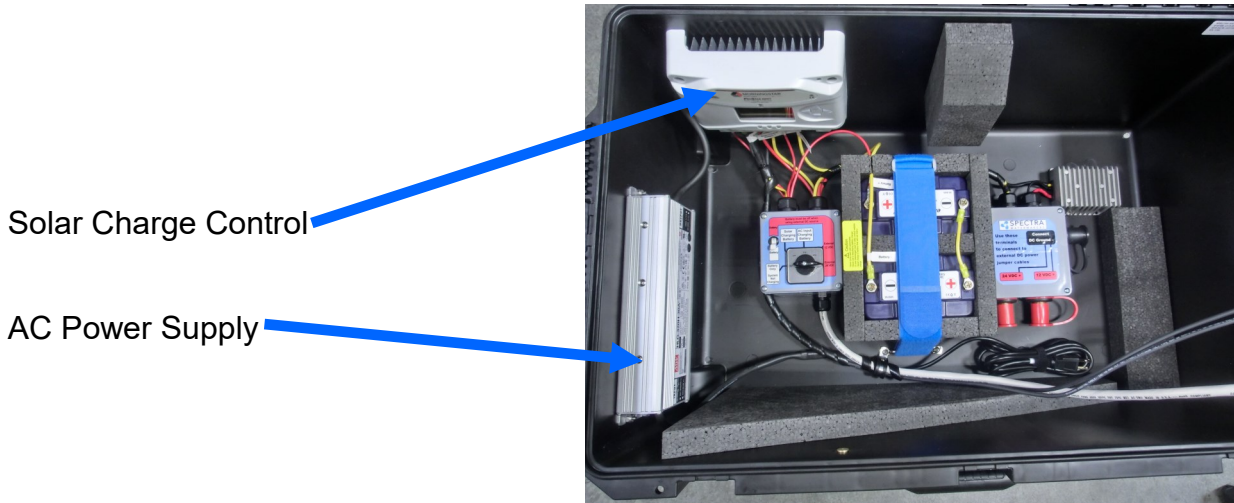

Solar Charge Control

AC Power Supply

The Solar Charge Control will display the power coming in, the battery voltage and the power being used. When the batteries are fully charged the input Amps will drop to below 1. Note that the load will disconnect (the pumps will stop if the battery voltage the battery voltage drops to about 25 volts (this is to protect the battery pack from over discharge). Once the battery voltage comes back up to about 26.5 volts the pumps will start again. If there is not full sun the system may cycle on and off as the battery drains and the input from the solar panels is not high enough to run the system.

Power Input
(no input shows a moon,
with input there will be a sun)

Battery Voltage

Power draw from
pumps in Amps

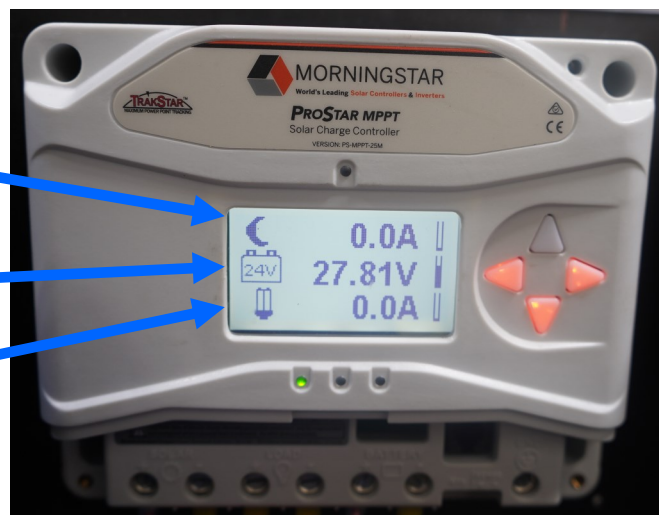

Optional Aquifer Expedition Solar Power Pack

Battery On/Off
Input Power source selector switch

There is a detailed description of the selector switch function in the Power Selection Guide on the next page.

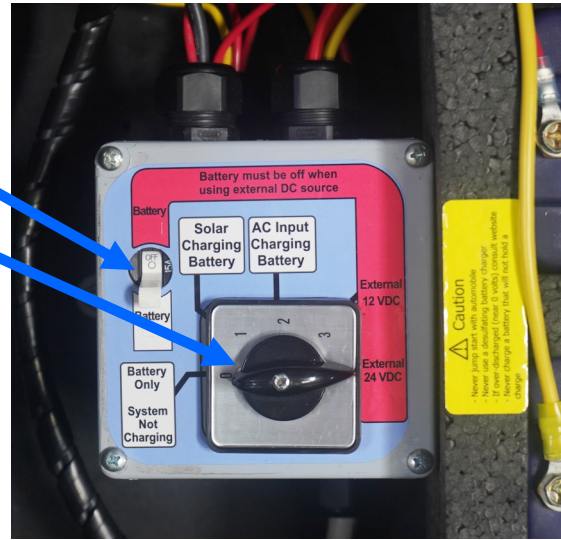

Note that the pumps can be plugged in or unplugged at any time. This is a low voltage DC system and there is no problem with unplugging or plugging in the pumps under load.







The Solar Panels are “daisy chained” together and it is not possible to connect them incorrectly.

- Connect the center panel to the panels on each side and then connect the remaining plugs to the cables from the power supply.
- The solar panels work best when the sun is directly over them so it will help if the panels can be set up at an angle so they are pointing at the sun.

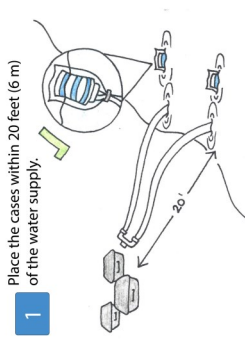

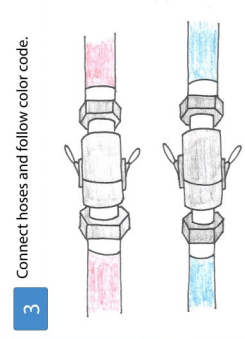
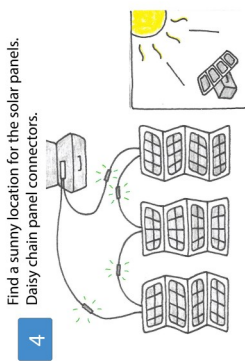
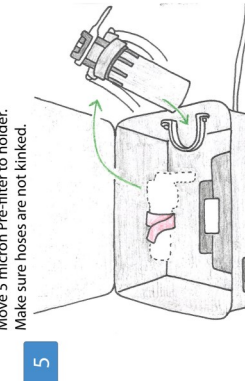
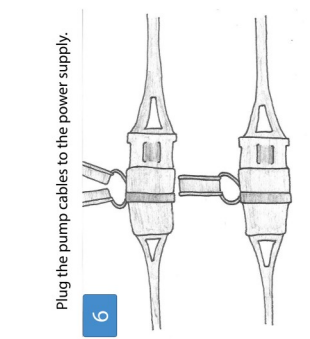
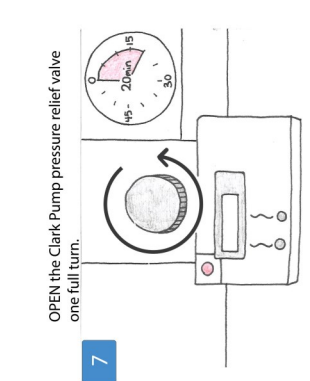
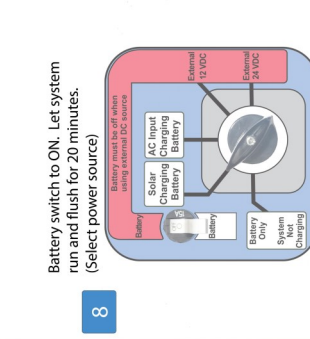
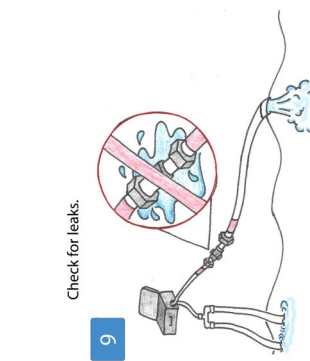
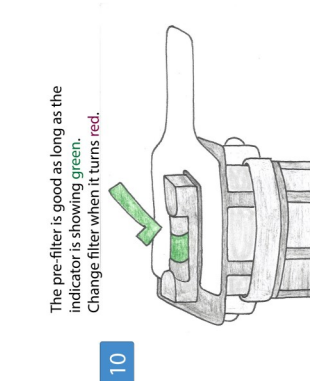
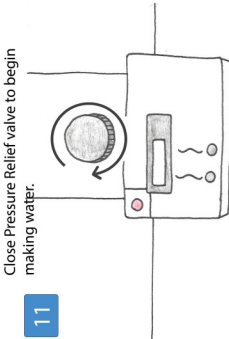
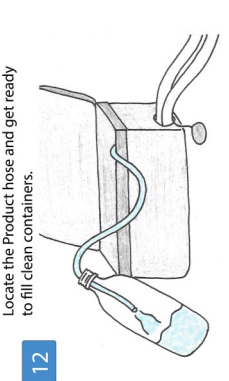
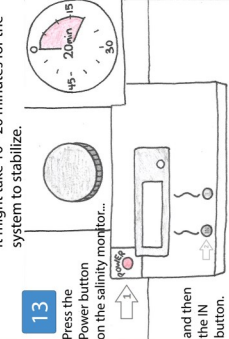
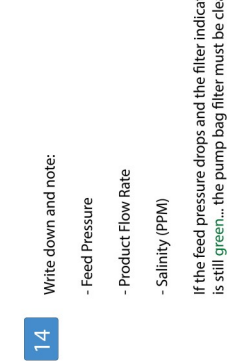
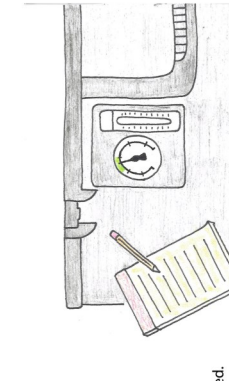
The system can also be powered with jumper cables from either a 12 VDC source (car or truck) or a 24 VDC military vehicle. **Remove the rubber boots to expose the jumper cable studs.**

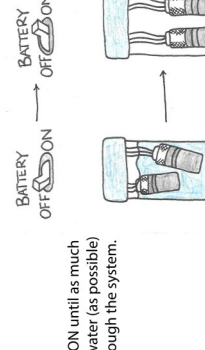

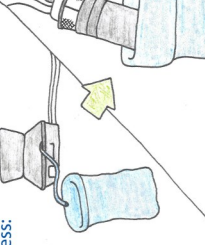
<p>1 Place the cases within 20 feet (6 m) of the water supply.</p> 	<p>2 Run the hoses out through the access port. Keep them clean.</p> 	<p>3 Connect hoses and follow color code.</p> 	<p>4 Find a sunny location for the solar panels. Daisy chain panel connectors.</p> 	<p>5 Move 5 micron Pre-filter to holder. Make sure hoses are not kinked.</p> 
<p>6 Plug the pump cables to the power supply.</p> 	<p>7 OPEN the Clark Pump pressure relief valve one full turn.</p> 	<p>8 Battery switch to ON. Let system run and flush for 20 minutes. (Select power source)</p> 	<p>9 Check for leaks.</p> 	<p>10 The pre-filter is good as long as the indicator is showing green. Change filter when it turns red.</p> 
<p>11 Close Pressure Relief valve to begin making water.</p> 	<p>12 Locate the Product hose and get ready to fill clean containers.</p> 	<p>13 Press the Power button on the salinity monitor... and then the IN button.</p> 	<p>14 Write down and note: - Feed Pressure - Product Flow Rate - Salinity (PPM)</p> <p>If the feed pressure drops and the filter indicator is still green... the pump bag filter must be cleaned.</p> 	<p>14 Write down and note: - Feed Pressure - Product Flow Rate - Salinity (PPM)</p> <p>If the feed pressure drops and the filter indicator is still green... the pump bag filter must be cleaned.</p> 
<p>Aquifer End of Production process:</p> <p>The system should be flushed with fresh water when finished. Fill one of the bags with fresh water. Turn off water maker and drop pumps into bag.</p>  <p>Turn pumps ON until as much of the fresh water (as possible) has gone through the system.</p>  <p>BATTERY OFF ON</p>  <p>BATTERY ON OFF ON</p> 				



SPECTRA
WATERMAKERS
AQUIFER 360
Flight Ready

Power Selection Guide

The top number on the display shows the power coming into the control from the solar panels or the AC power supply. There is a moon symbol with no power and a sun when power is coming in.

The battery symbol shows the battery voltage.



The light bulb symbol on the bottom shows the power being used.

Everything OFF - Not Charging

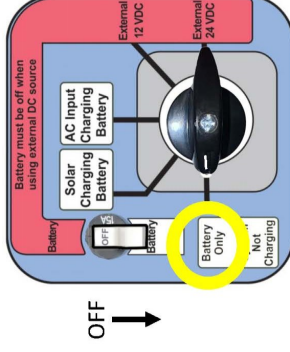

Watermaker ON - Not Charging

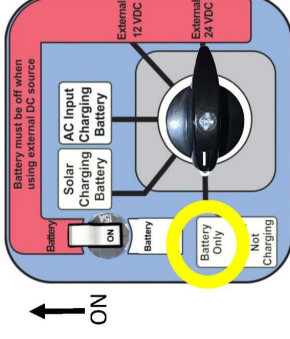

Battery Being Charged by Solar

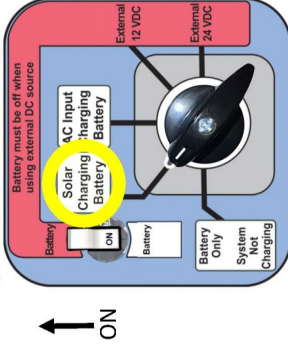

Battery Being Charged by AC

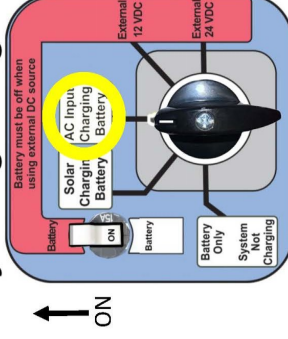

Watermaker Running on 12VDC From Jumper Cables

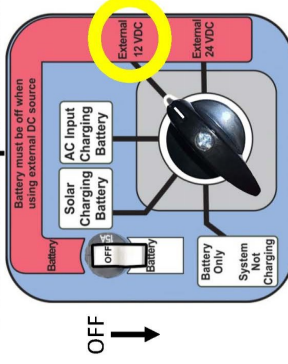

Watermaker Running on 24VDC From Jumper Cables

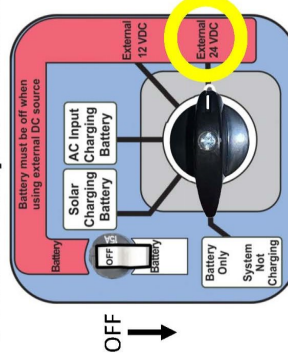

Aquifer Expedition Well Pump Connections

There is no on/off switch on the system as it is not required, just plug the power cord on the pump into the power cord coming from the unit.

When not in use keep the dust caps in place on the plugs to keep them clean. Clean connectors work much better.

When plugged in, the connection is water resistant (not water proof) so be sure it is never submerged in water.



Aquifer Expedition Well Pump Connections

The 100 Micron Filter Bag's primary purpose is to extend the life of the prefilters.

It also serves to keep the lid of the well pump case in close proximity should it accidentally become separated from the body of the case.



If the 100 Micron Filter Bag becomes clogged or dirty, simply remove the Velcro strap and untie the bag and leave to dry in the sun for at least 3 hours. The sun will kill any lingering bacteria clinging to the bag from the ocean or brackish well.



Next, wrap the Velcro strap around the loose ends so it will not come untied.



Aquifer 200/360 Plumbing Diagram

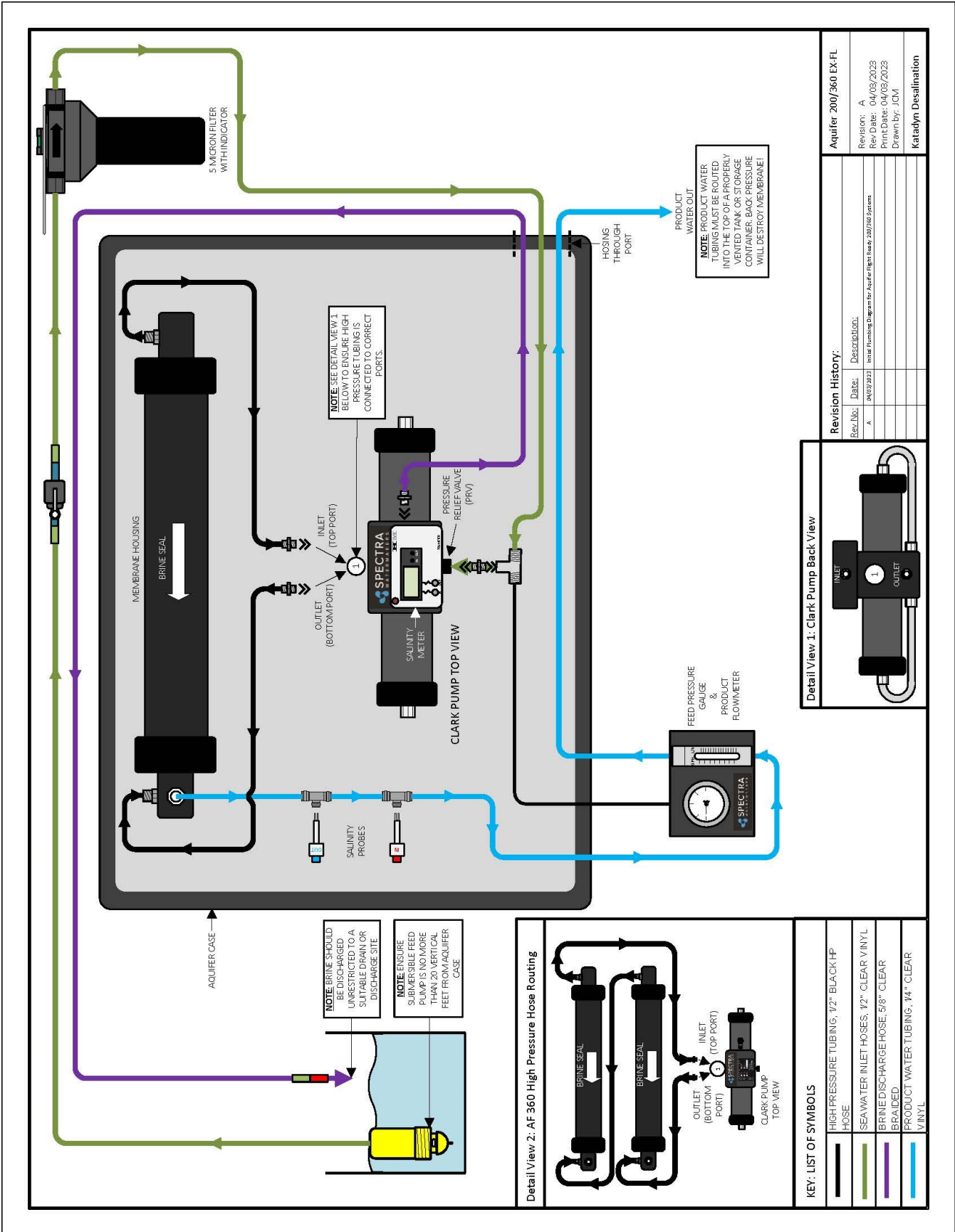

Revision History:	
Rev. No.	Date
A	04/03/2023

Initial Plumbing Diagram for Aquifer High Pressure 200/360 System

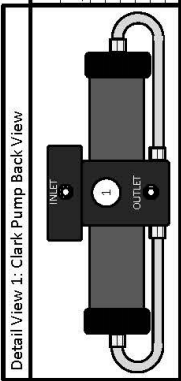

Revision History:	
Rev. No.	Date
A	04/03/2023

Initial Plumbing Diagram for Aquifer High Pressure 200/360 System

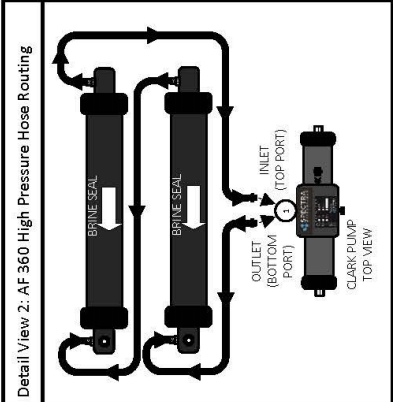

KEY: LIST OF SYMBOLS

- HIGH PRESSURE TUBING, 1/2" BLACK TP HOSE
- SEAWATER INLET HOSES, 1/2" CLEAR VINYL
- BRINE DISCHARGE HOSE, 5/8" CLEAR BRAIDED
- PRODUCT WATER TUBING, 1/4" CLEAR VINYL

Notes

Aquifer New System Start-Up and Testing

Warning! Your watermaker shipped from the factory with a non-toxic preservative to protect the internal membrane. **Damage will occur if this preservative is not flushed properly and the membrane is pressurized with preservative in it.**

DO NOT OPERATE the Aquifer system if the feed water contains oil as oil will foul the membrane.

1. First:

- Any feed water; salt, brackish, or fresh water will work for purging storage chemicals. You will need at least 50 gallons (200 liters) of **unchlorinated water**. **If only chlorinated water is available, replace the 5 micron filter with a Charcoal Filter element** during the flush to remove chlorine.
- Connect the feed, brine, and product hoses. Place the submersible pump into the feed water source far enough below the surface to prevent air from being pulled in. Place the end of the brine hose so that the brine does not mix directly back in with the feed water.
- Install the product hose and place the end of it so that any product will be discarded for the first 5-10 minutes of operation (after purging storage chemicals)
- **Ensure that the pressure relief valve is open a 1/2 turn.**
- Connect to a power source, 100 to 240vac, 12 or 24vdc using the marked terminals

Remove Tag and Washer!



Open 1/2 Turn and Purge System



2. Plug the feed water pump into the power cable. Note that there is no on/off switch, when you plug the pump in the unit will run. Check that the pump is submerged by inspecting the brine discharge for bubbles. About 1.5 gpm (6 lpm) of water should be being discharged with a (normal) pulsation every few seconds.

3. Run the system without pressure for at least 20 minutes to purge the storage chemicals, or at least an **hour if stored with propylene glycol**. The system should have an open flow pressure on the gauge of about 20 PSI (1.2 bar). Note that water may drip from the product tube.

4. When the above purge cycle is completed, close the pressure relief valve and the pressure will increase. After several minutes, water should begin to flow out of the product water tube.

5. Allow the system to run for 5-10 minutes to purge the product water of preservative, and then test the product with your handheld salinity tester. When the product is below 750 PPM it is considered potable and may be diverted to the water container for human consumption.

Aquifer Expedition Operation

Normal operation

If the system has been pickled or stored or contains cleaning compounds, use the “New System Startup” procedure.

1. Connect all the hoses per the color codes; blue is for the feed pumps and red for the discharge. The green hoses are connected for storage or shipping.
2. Check to see that the intake screen on the Submersible Pump is completely submerged in the source water. If using the float it may be helpful to place a rock on the hose to keep the pump in place.
3. Set up the product tubing so that the product is being discarded and it can be sampled.
4. Open the pressure relief valve, plug in the well pumps, turn them on with the selector switch on the power supply and check for flow by inspecting the brine discharge or checking for pressure on your pressure gauge.
5. When there is flow from the discharge tighten the pressure relief valve and check the product water quality. When it is below 750 ppm, you may divert it into your container.
6. Run the system until you have filled your tank or have made enough to meet your requirements plus 5 gallons for flushing the system.
7. Make about 5 gallons of water in one of the waterproof bags or a bucket to be used to flush the salt water out of the watermaker. **Use only unchlorinated water for flushing.**
8. Place the submersible pump in the bucket upside down so the screen pick-up is as low as possible and start the pump.
9. Flush until the pumps start to suck air and then stop the pumps.
10. Store the hoses inside the case and connect them together so no water drips in the case. Ideally allow the inside of the case to dry completely before storing.

You may now leave the system unattended for up to five days without further attention. We recommend operating the system for longer periods to conserve flush water. Remember that you need to run the system almost a half an hour to make the flushing water.

Be sure to rinse the feed pump(s) with fresh water after every use, cleaning the mesh strainer in the process. **It is recommended that everything be stored in a clean, dry place.**

Submersible
Well Pump

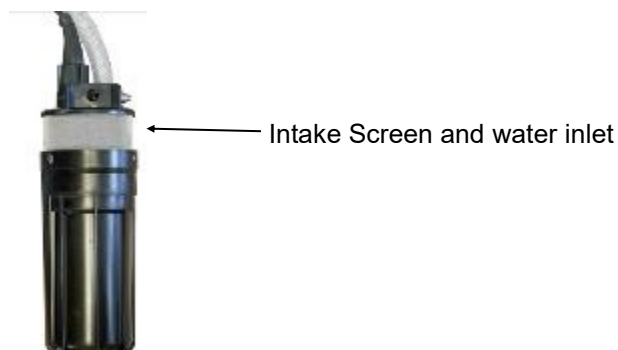

Aquifer Expedition Operation, Continued....

When the system has been running for about 10 minutes, record the pressure reading and product flow.

There are two things to monitor when operating the system;

1. The Green/Red filter indicator on top of the filter housing (Change filter when RED).

Note the filter can be placed on the ground to loosen the filter bowl as shown.

If the filter bowl gets stuck have someone tap on the housing (actually hit the label) with a hammer while applying pressure with the wrench.

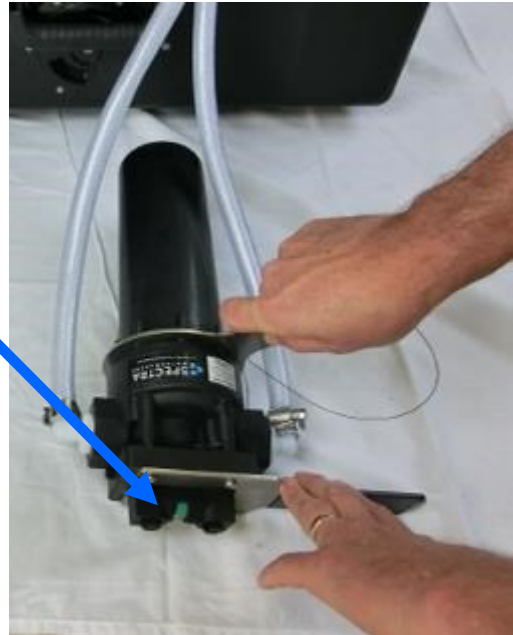

2. If the pressure drops and the filter is still green then the filter bag on the feed pump needs to be cleaned.

- Turn the pumps off
- Pull each pump out and clean 100 Micron Filter Bag (Use a hose or a running water source to rinse off the bag until all visible debris has been removed from the surface of the filter bag).
- If necessary, take the filter bag off the pump and clean it more vigorously using water and a scrubbing action to remove all visible debris that might inhibit consistent waterflow to the pump intake.



Aquifer Expedition Operation, Continued....

Filter Change

Rinse out the filter bowl and install a new filter as shown.



Be sure the filter is seated and not sticking up like this one.

O-ring



Run your finger around the O-ring on the top edge of the filter bowl and be sure it is free of dirt or debris.



Long Term Storage Procedures

Watermakers are best run continuously. When not in use, biological growth in the membrane is the leading cause of membrane fouling. A warm environment will cause more growth than a cold environment.

System Storage or “Pickling”

If the system is to be left unused for more than five days, perform the following storage procedure. The procedure introduces a chemical compound into the system that prevents biological growth. This procedure requires de-chlorinated water.

Spectra SC-1 is a special storage compound used by the US Navy. It is formulated to be compatible with the modern engineering plastics and composites in the Spectra pumps. Do not use any substitute except propylene glycol. If you wish to use glycol for storage, follow the winterizing instructions. SC-1 Storage Compound has to be mixed at a ratio of 1 container to 3 gallons (12L) of fresh water to have the proper solution for short term storage.

Caution! Avoid contact with skin, eyes, or breathing the storage chemical.

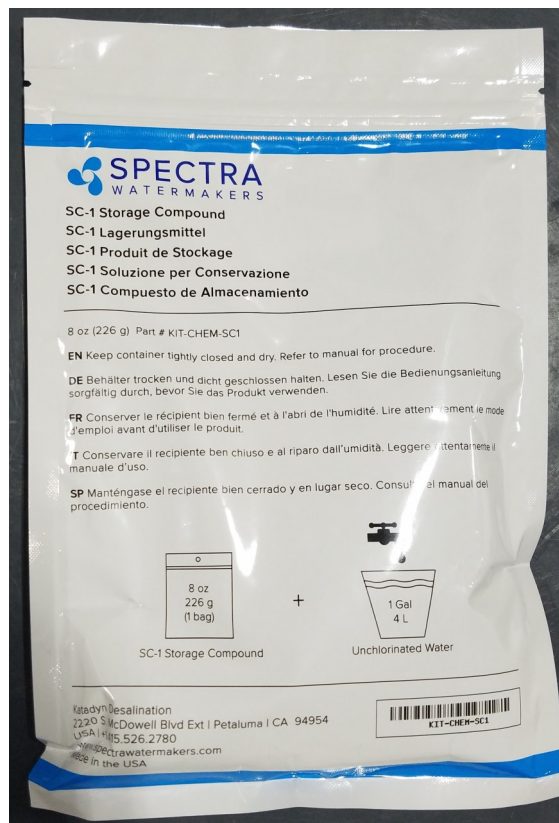

Aquifer Expedition Storage Procedure

1. Perform a fresh water flush as described in the Normal Operation section. Leave one gallon of water in the bucket.
2. Place the brine discharge in the bucket.
3. Add one packet of SC-1 storage chemical to the bucket and stir until mostly dissolved. The chemical will dissolve in about an hour, but don't worry if it doesn't all dissolve, it will not hurt the pump.
4. **Make sure the pressure relief valve on the Clark Pump is OPEN (unpressurized) by unscrewing it $1/2$ turn counterclockwise.**
6. Start and run the well pump to circulate the solution for about ten minutes.
7. Stop the well pump.
Leave the pressure relief open.

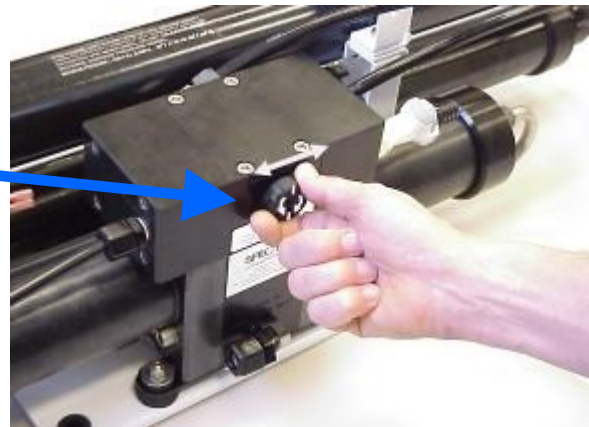

Clean Up

- Drain hoses as much as possible so there is no water to drip inside the case when the unit is stored.
- Disconnect the electrical connections and remove and stow the product tubing if the unit is to be transported.
- Remove hoses and stow it away in the case (connect quick fittings so any water in the hose is captured).
- Remove the pre-filter from its housing and replace with a clean dry filter element.
- Clean and dry the submersible well pump and stow inside the case.
- Allow the interior of the case to dry out if possible before storing.

Pickling and Winterizing with Potable Water Antifreeze

Do not use Potable Water Antifreeze that contains Ethyl Alcohol

The watermaker can be stored for any period **up to one year** in any climate using this procedure.

1. Perform a fresh water flush as described in the Normal Operation section.
2. Empty the bucket of water. There is one gallon of water in the system so add enough Low Temperature Propylene Glycol Potable Water Antifreeze into the bucket to obtain the freeze protection required following the chart on the bottle.
3. **Make sure the pressure relief valve on the Clark Pump is OPEN (unpressurized) by turning it $\frac{1}{2}$ turn counterclockwise.**
5. Start and run the Well Pump until antifreeze begins to come out of the Brine Overboard Hose.
6. Stop the Well Pump. Connect the brine service hose to the brine outlet on the Aquifer case and place it in the bucket.
7. Start the well pump and circulate the remaining antifreeze for a few minutes until well mixed.
8. Stop the well pump and discard any antifreeze remaining in the bucket.
9. Blow out or drain the product tubing, as it will not contain antifreeze.
10. **Leave the pressure relief open.**



Clean Up

- Drain hoses as much as possible so there is no water to drip inside the case when the unit is stored.
- Disconnect the electrical connections and remove and stow the product tubing if the unit is to be transported.
- Remove hoses and stow them away in the case (connect quick fittings so any water in the hose is captured).
- Remove the pre-filter from its housing and replace with a clean dry filter element.
- Clean and dry the submersible well pump and stow inside the case.
- Allow the interior of the case to dry out if possible before storing.

Maintenance

General

Periodically inspect the entire system for leakage and chafe on the tubing and hoses. Repair any leaks you find as soon as practical. Some crystal formation around the Clark Pump blocks is normal. Wipe down any salt encrusted areas with a damp cloth. If any rust appears at the Stainless Steel fittings, clean them up promptly. Keep the inside of the case dry and salt free.

The Submersible Well Pump

The Aquifer Expedition comes with a unique submersible diaphragm pump with an integrated seawater strainer. After each run cycle the well pump should be fresh water flushed, cleaned and stored dry to avoid premature damage. When the system is put into storage, remove, rinse, and dry the pump to impede corrosion. Check frequently during operation.



The Pre-filter

Service the pre-filter on a regular basis. When the pressure drops more than 5 psi on the gauge the filter becomes dirty. Do not leave dirty filters in the machine during long idle periods, as biological contamination could result.



To service the filter, swing the housing out of the case, open the housing using the supplied filter wrench, and discard or clean the old filter.

Clean out the housing bowl, reassemble the housing with a new 5 micron filter element. Leave dry until next startup. Use only Spectra approved filters or you may void your warranty. The filter may be cleaned a limited number of times by soaking it in water in a bucket and then letting them dry completely. Occasionally, lightly lube the filter housing O-ring with silicone grease.



The Clark Pump

The Clark Pump requires no routine maintenance except inspection for leaks. Tighten any hose clamps or fittings the show signs of leakage. The high pressure fittings threaded into the Clark Pump have O-ring seals with a straight thread. These should never leak and should never be over tightened. If one of the tube nuts starts to leak, it can be un-threaded, sealed with a bit of silicone grease or silicone seal, and tightened with two wrenches very tightly.

Aquifer Membranes Maintenance and Cleaning

The membranes need to be cleaned only when feed pressure begins to rise due to fouling or the product quality degrades. The leading cause of fouling is from biological growth that occurs when the system is left unused without flushing or pickling. Fouling from mineral scaling can happen during operation under certain source water conditions, and from rust. Monitor the product salinity and feed pressure for higher than normal readings for the existing conditions.

Other conditions can cause high pressure such as cold feed water or clogged filters.

Low product flow is usually due to low voltage, a damaged well pump, or Clark Pump problems. Look for all other causes before cleaning the membrane as excessive cleaning shortens membrane life.

There are two types of cleaners: acid and alkaline. The acid cleaner (SC-3) will remove mineral scaling. The alkaline cleaner (SC-2) is used to remove biological by-products, oil, and dirt particles that get past the pre-filter. If membrane performance is reduced and they have not been “pickled” recently, cleaning with both chemicals is recommended. The acid cleaner should be used first followed by the alkaline cleaner. If the membrane fails to respond to both cleanings, this is an indication of another problem with the system, or that it is time to replace the membrane. Contact Spectra Watermakers before removing a membrane.

Membrane Cleaning

For normal cleaning, the SC-3 Acid Cleaning Compound is used first, then the SC-2 Alkaline Cleaning Compound. If known bio-fouling is present (rotten egg smell) the SC-2 may be used first. Using hot water if possible, up to 120° (45C) is recommended as it greatly enhances the ability of the cleaners to do their jobs.

If the history of the system is unknown or it has been left “unpickled” for an extended length of time and biological growth is present, it is recommended that the system is cleaned with SC-2, using an alternate source of unchlorinated fresh water before the system is run under pressure. A simple test can be performed to see if biological growth has occurred. Before running the system, remove the prefilters and examine their condition. If the housings are full of smelly discolored water, the system was not properly stored. Install clean prefilters if they were bad. Next check the membrane. Attach the brine service hose and lead it to a bucket. Open the pressure relief valve one turn, and run the system for 30 seconds. Examine the brine water: if it's discolored and smells bad, perform an SC-2 cleaning with an alternate source of unchlorinated water before running the system pressurized. If the brine is fairly clean, the system can be purged, run normally, and checked for performance. Clean the membranes only if performance is reduced.

Heating the water is preferable. One way to do this is to find a camp stove and use a large stainless steel pot to heat the solution in. The cleaning solution throughout the system will heat as it circulates in and out of the pot. An alternative is to heat the one or two gallons of initial water to 120° on the main stove before mixing in the cleaner and circulating it into the system. Periodically stop and reheat the solution.

Perform the cleaning procedures and then test on a normal feed water supply.

Membrane Cleaning

Note that the Procedures are the same for the SC-2 (alkaline) and SC-3 (acid) cleaners

Spectra cleaning compound (SC-2 or SC-3) must be mixed with fresh water at a ratio of 1 packet of compound to 3 gallons (12L) of unchlorinated water to have the proper solution. About 2-3 gallons (8-12L) of water is already present inside an Aquifer system. This water has to be figured into the mixture. An Aquifer system will use one packet of compound.

Cleaning Procedure:

1. Freshwater Flush by filling a bucket with 5 gallons of unchlorinated water and placing the submersible pump in the bucket upside down and the brine discharge hose going to a drain. Run as much of the fresh water through the system, tilting the bucket as it empties until the pump is sucking air.
2. Fill the bucket with 2 gallons of water. Heating the water to 120° [45C] (hot but you can keep your hand in it) will make the process much more effective.
3. Put the brine discharge hose in the bucket so the water in the bucket will circulate through the system and go back into the bucket.
4. **Make sure that the pressure relief valve is OPEN** (un-pressurized).
5. Pour one packet of the cleaning chemical in the bucket and start the pump. Note that it may take up to an hour for the chemical to dissolve. The chemical particles will not hurt the pump or the system and they will eventually dissolve.
6. If starting with hot water, start the system and circulate the chemical for 20 minutes, allow the system to soak for an hour or more and then run the system for another 20 minutes. Go to Step 8.
7. If not using heated water run the pump for two hours and let it sit overnight. The next day run the pump for two hours.
8. Stop the pump, move the brine discharge hose to a drain and start the pump until the bucket is empty. Move the pump to a feed water source.
9. Follow the instructions for 'New System Start Up' previously in this manual to purge the chemicals from the membrane. **(DO NOT CLOSE the pressure relief valve until the cleaning chemical has been purged for at least an hour)**
10. The system can now be restarted to make water, fresh water flushed, or stored.

Suggested Spares

2 Months Spares.

We suggest a basic cruise kit A. This kit consists of six 5 micron filters, and 2 SC-1 storage chemicals.

Up to 6 months

Two basic cruise kits

Longer than 6 months

Additional filters, Offshore Cruising Kit consisting of Clark Pump seals, O-rings, tools and membrane cleaning chemicals. O-ring for strainer screen, O-rings for filter housing

Spectra Watermakers parts list:

	Part Number
SC-1 STORAGE COMPOUND	KIT-CHEM-SC1
SC-2 ALKALINE CLEANING COMPOUND	KIT-CHEM-SC2
SC-3 SCID CLEANING COMPOUND	KIT-CHEM-SC3
SUPPORT KIT 6EA 5M FILTERS, 2EA OF SC-1,2 & 3	KIT-AF-SPK
5 MICRON FILTER ELEMENT	FT-FTC-5
FILTER HOUSING O-RING	SO-FHS-10H
OFFSHORE KIT FOR 7% & 10%	KIT-OFFSH
20" HIGH REJECTION MEMBRANE (FILMTEC)	KIT-MB-20F
10% CLARK PUMP REBUILD KIT	KIT-HP-10UD
SEAL & O-RING KIT	KIT-HP-S&O

Troubleshooting Aquifer Systems

Symptom	Cause	Remedy
Well pump runs but no pressure	Well pump air locked Pressure relief valve open	Open pressure relief valve to bleed the air then close to start Close pressure relief valve
High Feed Water Pressure	Prefilter clogged Closed valve or blockage in flow	Change filter Check flow path for closed valve or kink in hose
Low water production High amperage High feed pressure	Strainer or pre-filter clogged	Service pre-filter and strainer
Low water production, Low pressure	Pressure relief valve partially open Worn pump head	Close valve Check flow should be 1.5 GPM from brine discharge with pressure relief valve open Replace well pump
Water production normal High feed pressure high amperage	Cold seawater temperature Fouled membrane	Normal condition Clean membrane
Water production normal but; Lower pressure Lower amperage	Warm sea water or brackish water.	Normal condition
Asymmetrical pressure and flow readings between pump shifts	Check valve leaking Failed annular ring Shaft seal leaking	Contact dealer or see the Clark Pump repair manual.



Poor Product Water Quality

With any product water quality issue, you must ensure accurate calibration if you are using a salinity meter. For general quality evaluation, your taste is always good enough.

Membranes are not an exact science and two identical systems can have different product quality. World health standards deem water of up to 1000 PPM of total dissolved solids acceptable for drinking consumption. We consider any thing below 750 PPM acceptable but not ideal, and anything below 500 PPM excellent. Factors that could affect water quality are addressed below.

LOW SYSTEM FLOW OR PRESSURE will equate to lower product quality (higher PPM). Aquifer systems, which have a higher feed to output pressure ratio (See nominal pressures under Flow Test), as well as a higher feed flow/membrane area ratio, will produce water in the 150-200 PPM range.

DAMAGE TO THE MEMBRANE by chlorine contamination. Flushing the system with chlorinated water will irreparably damage the membrane. Charcoal filters are used to absorb any chlorine which might be present in flush water. They must be of proper specification to be suitable. There is no test for chlorine damage except the process of elimination of other causes.

DIRTY OR SCALED membranes. A dirty (foreign material), scaled (mineral deposits), or contaminated (bacterial growth) membrane can result in poor water quality and abnormal operating pressures. If operating pressures are above normal, then cleaning is indicated. If the system pressures are within operating normal range, cleaning may have little result. Avoid cleaning as a diagnostic tool. Low water quality after storage with propylene glycol can usually be remedied by extended flushing or an SC-2 cleaning.

MECHANICAL LEAKAGE within the membrane pressure vessel. This is an unlikely but possible cause of poor water quality with old style Codeline pressure vessels (white). The Spectra pressure vessel has a double O-ring arrangement that includes a telltale hole between them so that any salt water leaking past an O-ring will drip into the case and not go into the product water.

If system flow (product plus brine) is 1.5 GPM or above, the membrane is clean, the product flows are consistent with the system flow and the water quality is still not acceptable, then replacement of the membrane is indicated.

DWYER FLOW METER SERVICE

The mechanical flow meter, can be opened for cleaning if it becomes difficult to read or if the little ball gets stuck.

The flow meter will come completely apart for cleaning;

1. First remove the meter from the panel (which may require the plumbing fittings to be removed) by removing the brackets that hold it to the gauge panel.
2. On the very top of the meter is a clear plastic key that slides into place holding the top cap of the assembly in place. Use a small flat bladed screwdriver to pull the key out..
3. Hold the meter upright (or the ball will fall out) and then lever the top cap off. It is hard to see but there is a small notch in the back of the cap where you can put the small screwdriver and begin to pry the cap off. The cap will move easily so if you to apply too much pressure you are likely pushing on the wrong place.
4. Invert the flow meter and catch the ball as it falls out.
5. You can use tooth paste or plastic window polish to polish the inside using a small bottle brush or a Q-tip.
6. Clean the ball and give it a few coats of wax.
7. If the O-rings are damaged or the unit has been leaking, install new O-rings using a little silicone grease to ease assembly. These are standard O-rings and should be available at most larger auto parts or bearing stores. Reassemble in reverse.

OP-2 BAD SMELLING PRODUCT WATER

The reverse osmosis membrane is permeable by many gases including hydrogen sulfide, the gas that causes rotten eggs to smell the way they do. If there are bad odors in the feed water they will go through the membrane and the product water will be affected. Usually the source of the odor is from the decay of planktonic creatures trapped in the sea strainer and prefilters. These tiny oxygen loving creatures soon suffocate and die inside the prefilter housings when the unit is shut down. Once all the available oxygen is consumed, anaerobic bacteria begin to grow, causing the odor. If a unit being used frequently begins to make smelly water, usually the prefilters are the source of the problem. This occurs in a week or two in cold climates, but in less than one night in very warm waters like the Sea of Cortes or the Red Sea. These bacteria can spread throughout the watermaker, and begin to grow on the membrane, causing poor water quality and high feed pressures.

Filling the system with fresh water after every use greatly slows this process, allowing the automated Spectra units to operate with less frequent prefilter changes, but units operated for only an hour or so each day will probably need to have the filters changed due to odor before they are dirty enough to restrict water flow. Prefilters can be cleaned. We recommend that you have three sets in service: one in the unit, one set soaking overnight in a bucket of clean fresh or salt water, and one set drying for the next use. After shutting down the unit, remove the used prefilters and install the dry set. Leave the housings full of air until the next use. On non-automated systems, open the pressure relief when starting if there is a lot of air in the system until the air is cleared out through the brine overboard. The filters will get just as clean when soaked in sea water, but dry much faster if soaked in fresh. Given gentle handling, prefilters can be reused many times.

Bad smelling product water is usually caused by bad smelling feed water, but can also be caused by a fouled membrane if the membrane has been left unpickled. If the unit makes smelly but not salty water after a long idle period and the prefilters are new, the smell can be eliminated by running the unit unpressurized for an hour or so to flush the membrane.

Odors in the product water can also be eliminated by adding a charcoal filter in the product water line. Spectra offers a product water filter kit (part no. KIT-FLT-CC).

More on this subject is available on our website at www.spectrawatermakers.com.

8/17/04

Wiring Diagram

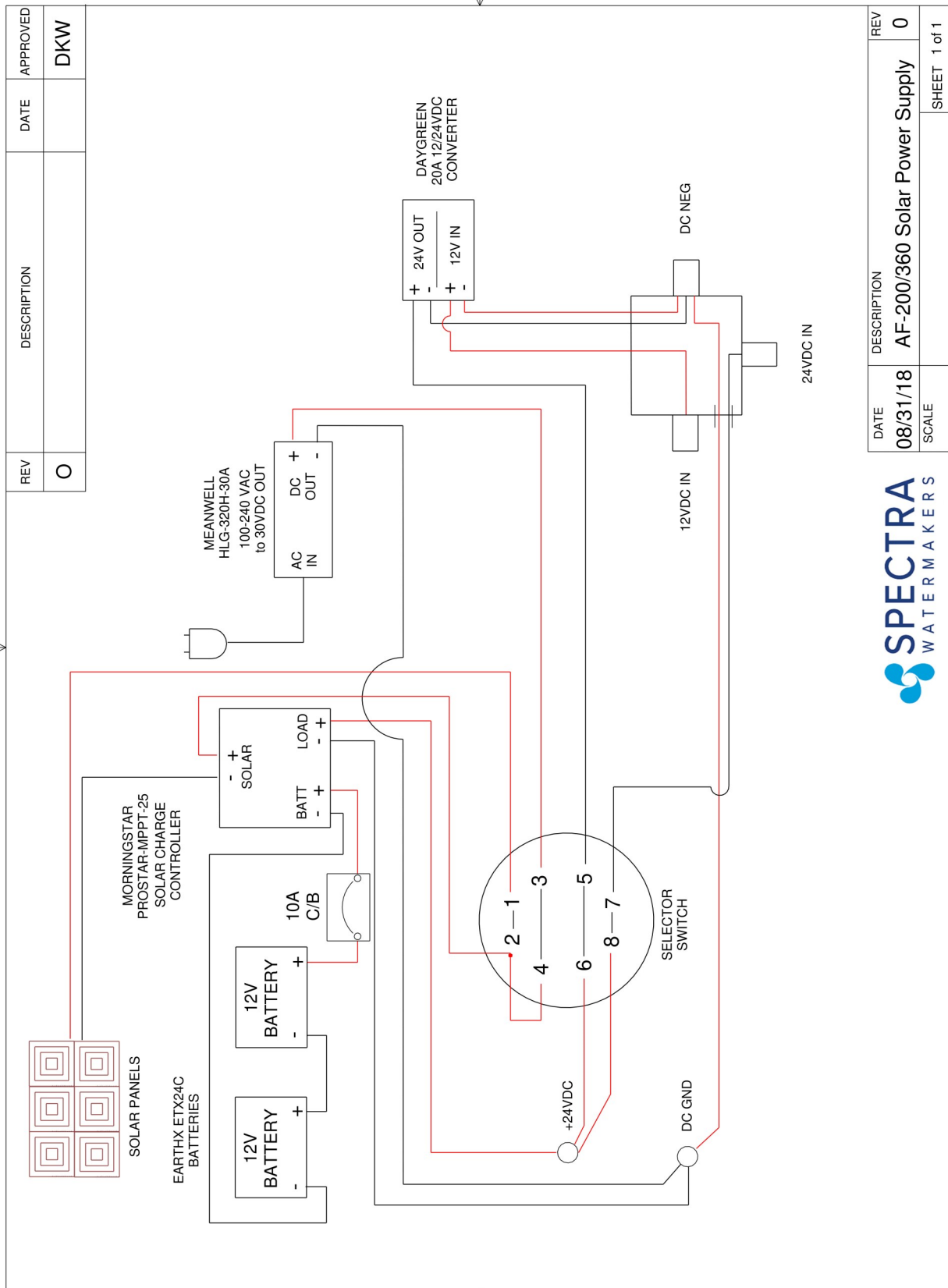

REV	DESCRIPTION	DATE	APPROVED
O			DKW

DATE	DESCRIPTION	REV
08/31/18	AF-200/360 Solar Power Supply	0
SCALE		SHEET 1 of 1



John Guest Super Speedfit Fittings

How Super Speedfit Works

To make a connection, the tube is simply pushed in by hand; the unique patented John Guest collet locking system then holds the tube firmly in place without deforming it or restricting flow.

Materials of construction

Super Speedfit fittings are made up of three components:

Bodies are produced in an acetal copolymer or polypropylene.

'O' rings are Nitrile rubber or EPDM.

Collets are produced in acetal copolymer or polypropylene with stainless steel teeth.

How to make a connection

Cut the tube square



Cut the tube square and remove burrs and sharp edges. Ensure the outside diameter is free of score marks. For soft or thin walled tube we recommend the use of a tube insert

Push up to tube stop

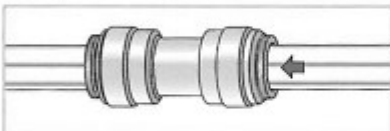

Push the tube into the fitting, to the tube stop.

Pull to check secure

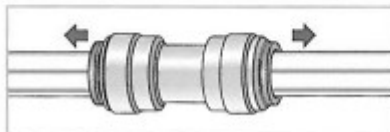

Pull on the tube to check it is secure. Test the system before use.

Grips before it seals

'O' ring provides a leakproof seal

The Collet (gripper) has stainless steel teeth which hold the tube firmly in position while the 'O' ring provides a permanent leakproof seal.

Stainless steel teeth grips the pipe

Collet

To disconnect

Push in collet and remove tube

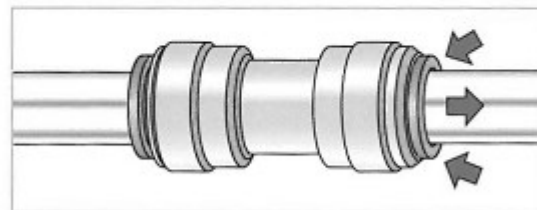

To disconnect, ensure the system is depressurized, push the collet square against the fitting. With the collet held in this position the tube can be removed.

Parker (Black) Tube Fittings

Note; the plastic nut only needs to be finger tight as the fitting uses an O-ring seal and the nut is only holding the grab rings in place. Overtightening may strip the threads and render the fitting useless.

Fast & Tite® Thermoplastic Fittings

Fast & Tite® fittings are the most complete line of plastic fittings for thermoplastic tubing in the industry.

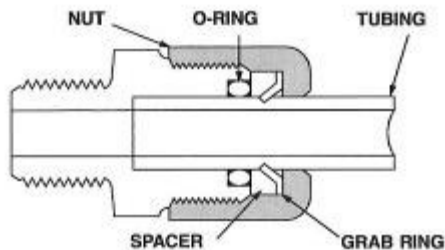

Fast & Tite® thermoplastic tube fittings from Parker will prove to be the answer to your tubing connector needs. Patented Fast & Tite® fittings install in seconds without tools and provide a tight, sure, leak proof seal without clamps or adjustments. A unique 302 stainless steel grab ring for tube retention, coupled with a Nitrile O-Ring for positive seal, assures good tube connection with only hand tight assembly. A plastic grab ring is also available upon special request. Vibration or tube movement will not break the seal and cause leakage. Preassembled in either highly inert polypropylene, or strong, durable nylon, Fast & Tite® fittings are the answer to full flow thermoplastic tubing system requirements.

When necessary, Fast & Tite® fittings can be disassembled by hand for fast system drainage. Fittings are completely reusable.

Parts are easily replaced. O-Rings are standard size and universally available. (For applications requiring other than Nitrile O-Rings, consult your Fast & Tite® distributor.)

Use Fast & Tite® fittings with Parker Parflex tubing or other plastic, glass or metal tubing for low pressure or vacuum lines up to the pressure limits shown below.

Fast & Tite® fittings meet FDA and NSF-51 requirements for food contact.

Working Pressures for Fast & Tite® Fittings

Tube O. D., in.	Air-Oil-Water Pressure in PSI		
	Up to 75°F	76° to 125°F	126° to 175°F
1/4	300	300	300
5/16	300	300	300
3/8	250	250	150
1/2	200	200	150
5/8	150	100	50

Ratings are based on use with copper tubing, and in all cases represent the maximum recommended working pressure of the fitting only. Working pressures (vs. temperatures) of other types of tubing may limit the tube and fitting assembly to pressures lower than shown above. Consult factory for recommendations on applications other than shown above.

Temperature Range:

Black/White Polypropylene: 0°F (-18°C) to +212°F (+100°C)
White Nylon: -40°F (-40°C) to +200°F (+93°C)

Fast Assembly

Step 1.

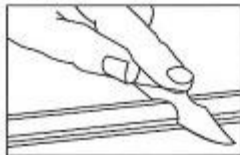

Cut the tube squarely and remove any burrs.

Step 2.

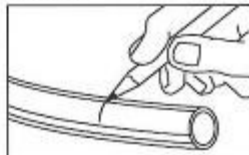

Mark from end of tube the length of insertion. (See table below)

Tube O.D. (in.)	Insertion Length with Tube Support (in.)	Insertion Length without Tube Support (in.)
1/4	5/8	9/16
5/16	5/8	9/16
3/8	13/16	3/4
1/2	7/8	13/16
5/8	1	15/16

Step 3.

Loosen nut on fitting until three threads are visible. Fittings for glass tubes must be disassembled and the grab ring removed.

Step 4.

Moisten end of the tube with water. Push the tube **Straight** into fitting until it bottoms on the fitting's shoulder. Tighten nut by hand. Additional tightening should not be necessary, but 1/4 additional turn may be added if desired. **Do not overtighten** nut as the threads will strip and the fitting will not function properly. A proper assembly will not show the insertion mark extending beyond the nut. If the insertion mark is visible, then steps 1 thru 4 must be repeated.

Step 5.

When using clear vinyl tubing or urethane tubing, it is necessary to use a **TS** tube support. Disassemble the fitting and place the nut, grab ring, spacer and tube support, in that order on the tube. Locate the grab ring at the insertion mark as shown. Seat the O-ring in the body, then proceed with Step 4.

Note: Provide adequate fail-safe mechanisms such as leakage detection sensors, automatic shut-off controls or other industry and code appropriate fail-safe devices in the design of your water-handling appliance to protect against personal injury and property damage.

Plastic fittings containing an o-ring that are used in water applications should be replaced at least every five years or more frequently depending on the environment and severity of the application.

Spectra High Pressure Tube Fitting Assembly Instructions

The Watermaker has eight high-pressure fittings, two on each cylinder on the Clark Pump, two on the pressure vessel end caps, and two 90-degree elbows on the back of the Clark Pump. As the compression fitting is tightened, it compresses a ferrule onto the stainless tubing, fixing the ferrule permanently to the tube and holding the compression nut captive.

The body of the fitting seals to the underlying component with an O-ring. On the Clark Pump cylinders and the end caps this O-ring is compressed by tightening the entire fitting. The O-rings on the 90-degree fittings on the back of the Clark Pump have captive nuts and washers, which compress the O-rings without turning the entire fitting.

If a tube fitting leaks it can sometimes be resealed by just tightening. You must use two wrenches, a 13/16-inch wrench to hold the base, and a 7/8-inch wrench to turn the compression nut. The 13/16-inch wrench will need to be thin so as not to interfere with the compression nut. If this doesn't work, disassemble the fitting, grease liberally with silicone grease (the ferrule and the threads) and re-tighten firmly.

The base O-rings should be **gently** compressed to achieve a good seal, and may be damaged by overtightening. As long as the metal washer is in contact with the block, the O-ring will seal.

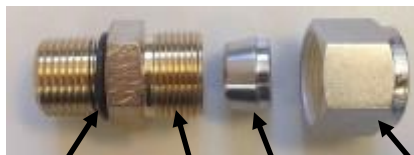

Connector O-RING

Ferrule

Stainless Fitting Hex Nut

Nickel-Bronze High Pressure Straight Fitting



Nickel-Bronze High Pressure Elbow

Part Numbers

Front View



CLARK PUMP
KIT-HP-10

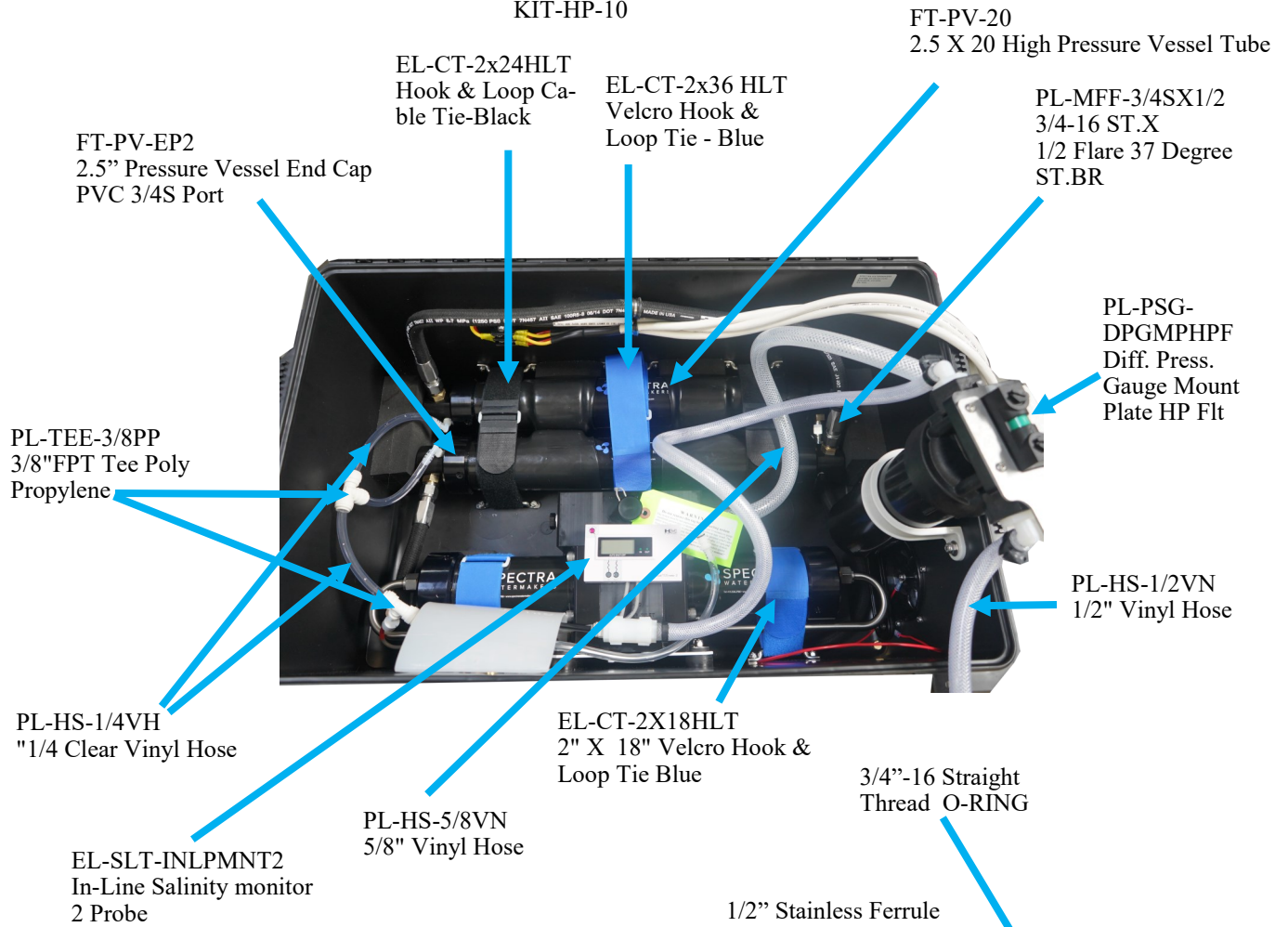

Connector O-RING
SO-HPP-CT



Stainless Fitting Hex Nut
PL-HWR-1/2HN



Part Numbers

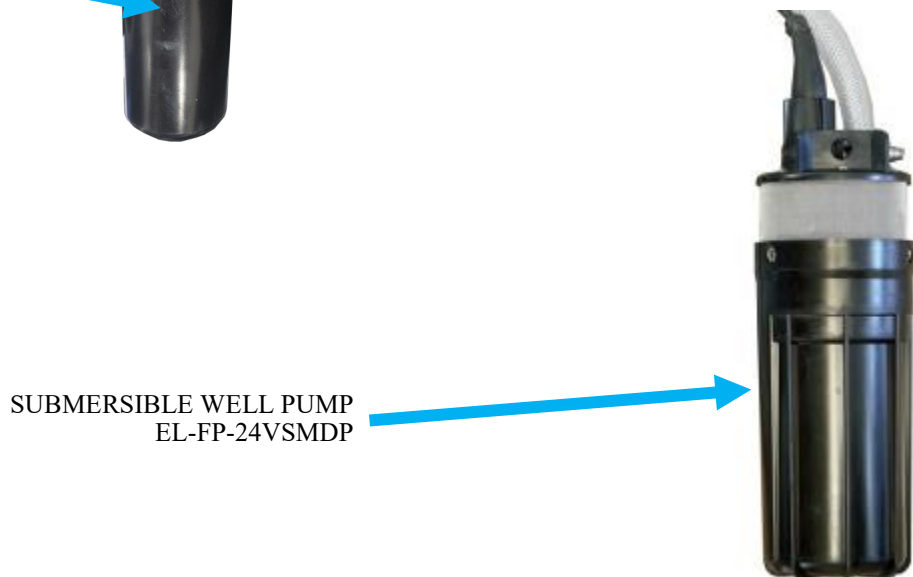
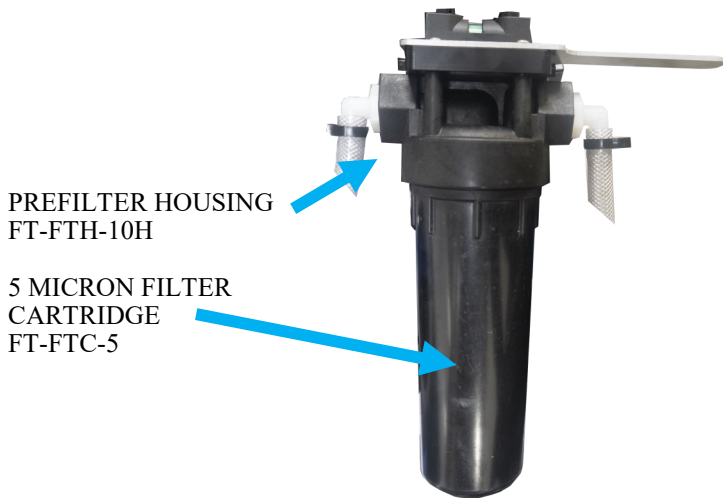
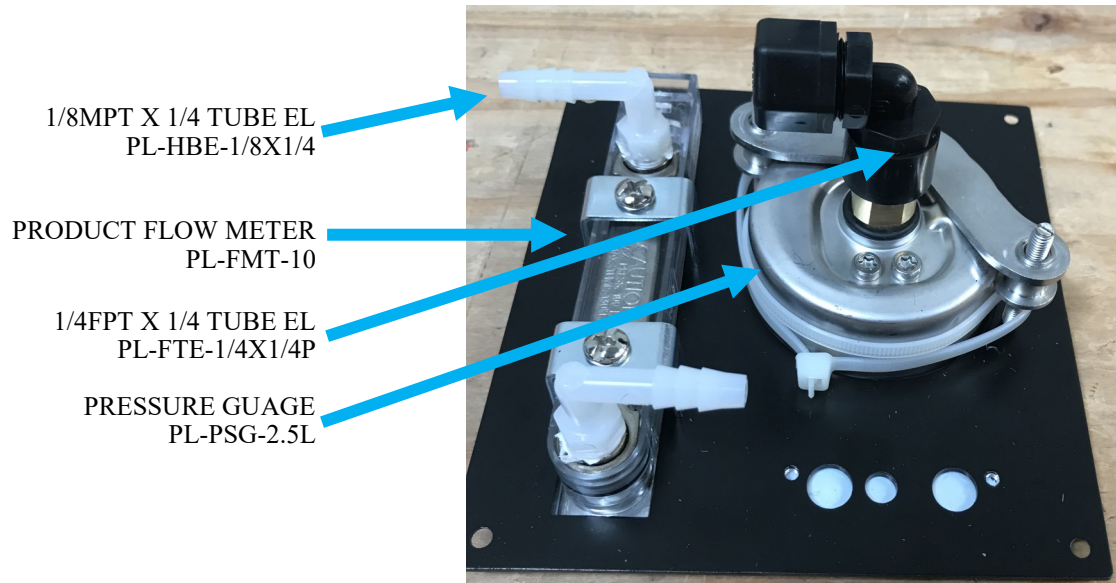

Clark Pump Assembly

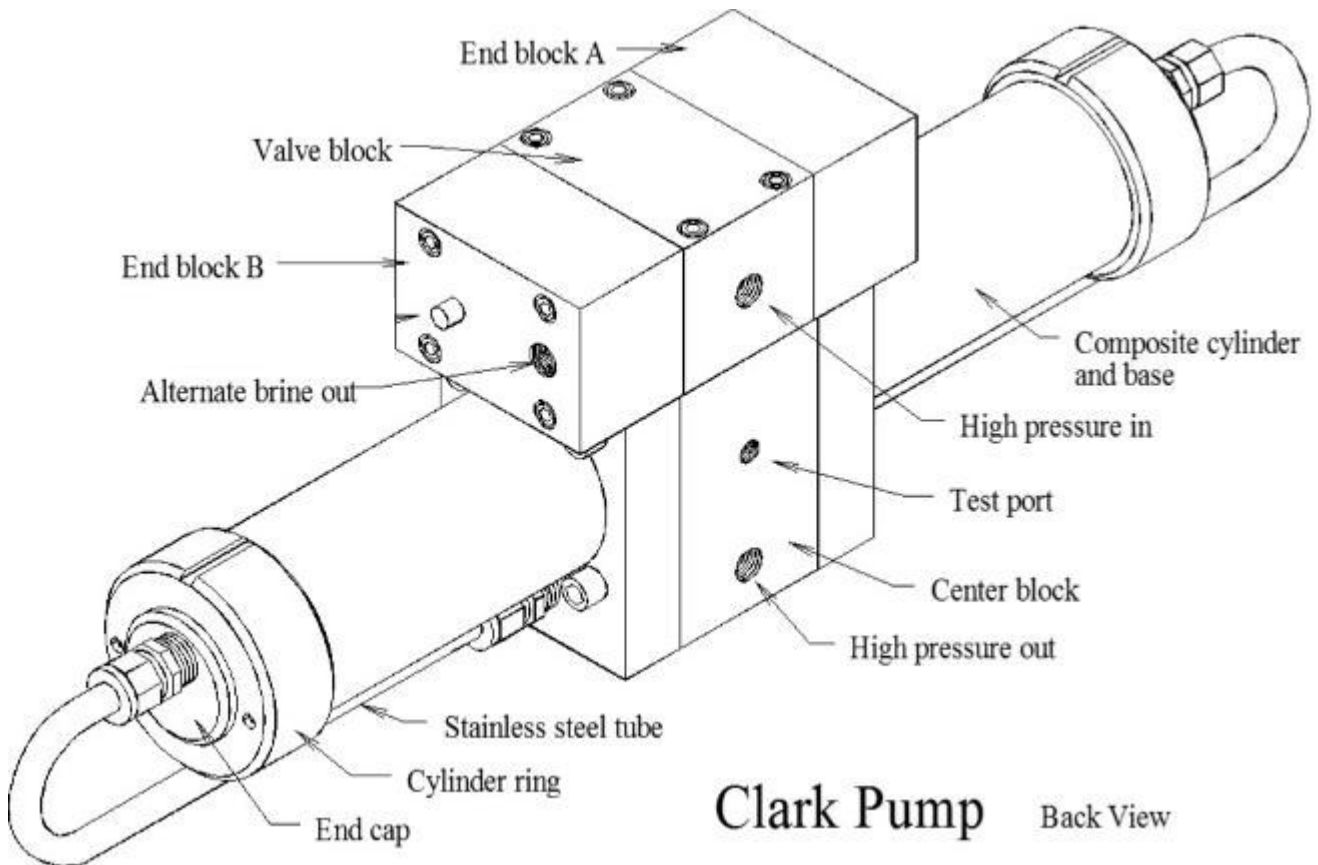
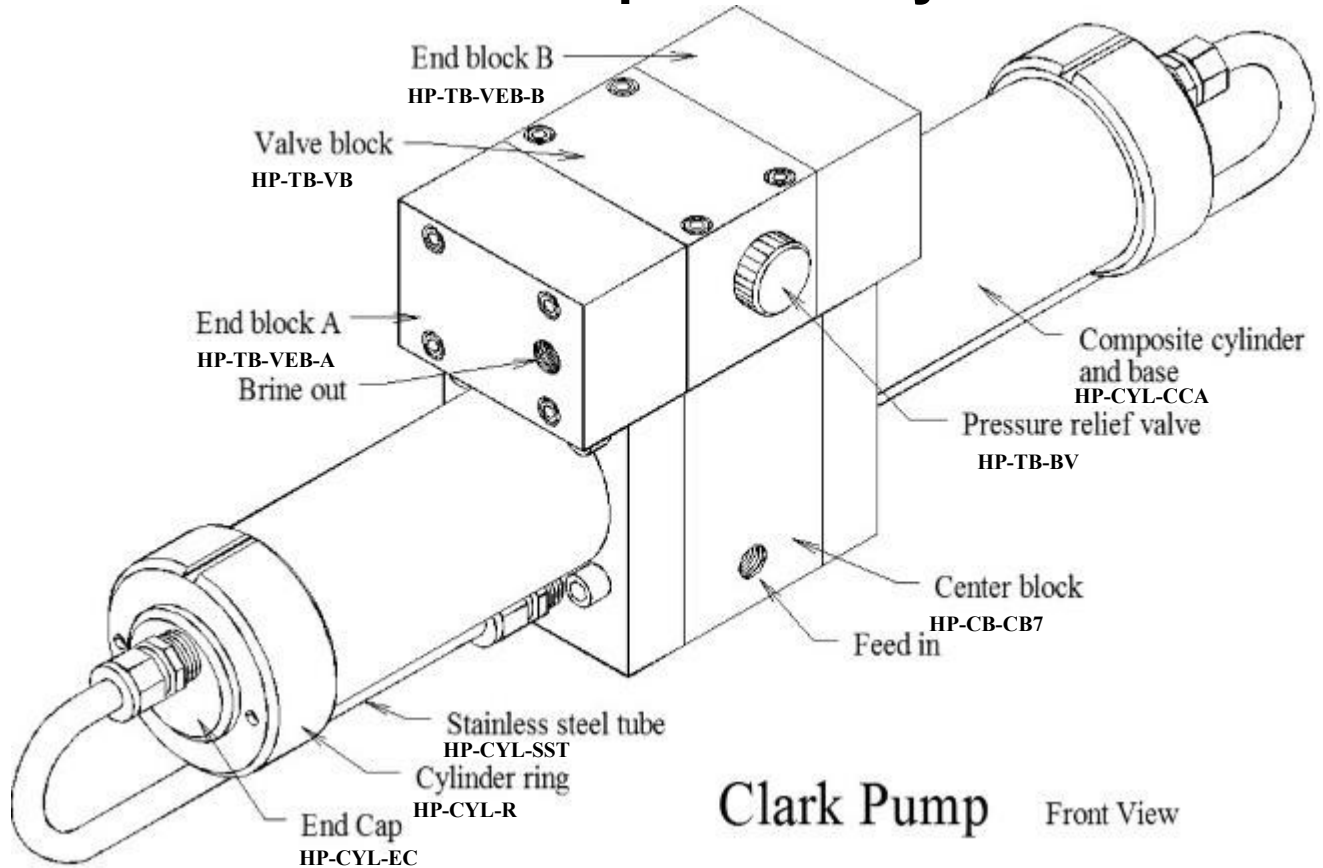

Spool Assembly
Exploded View

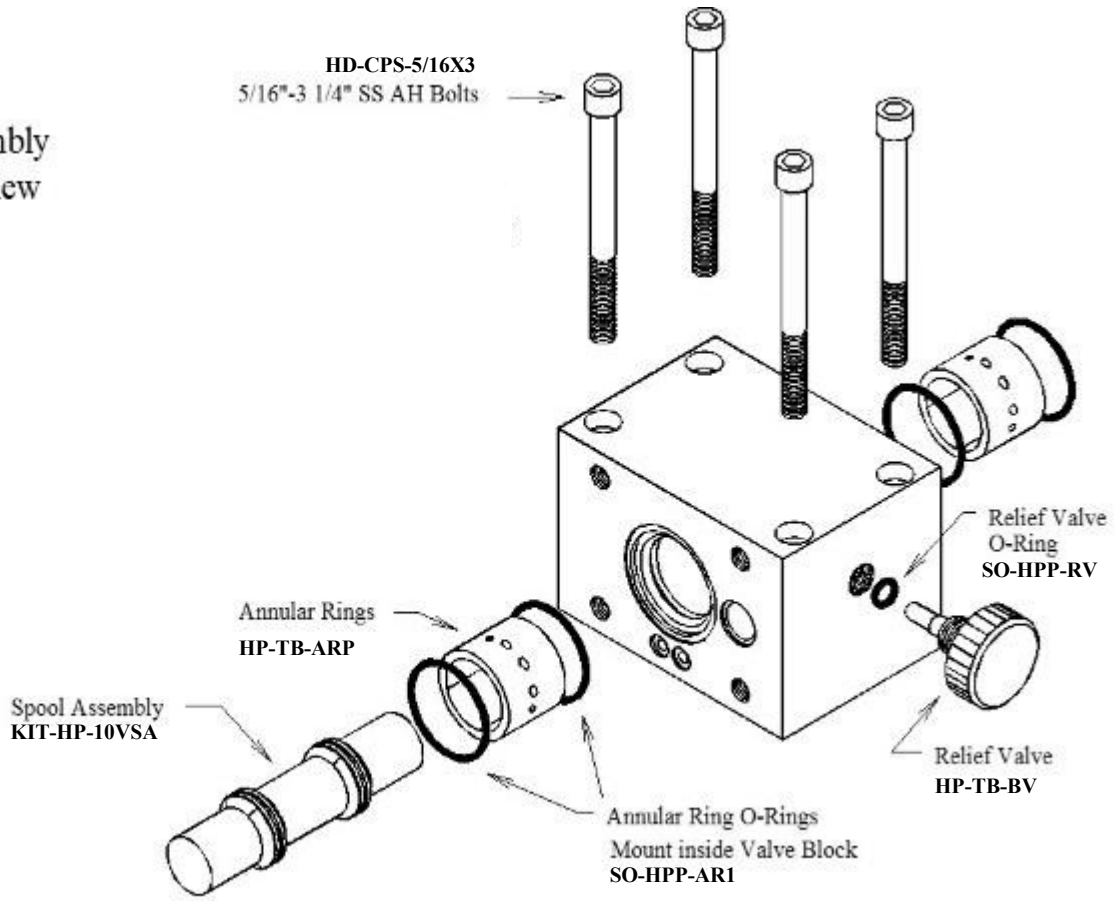

Valve Block

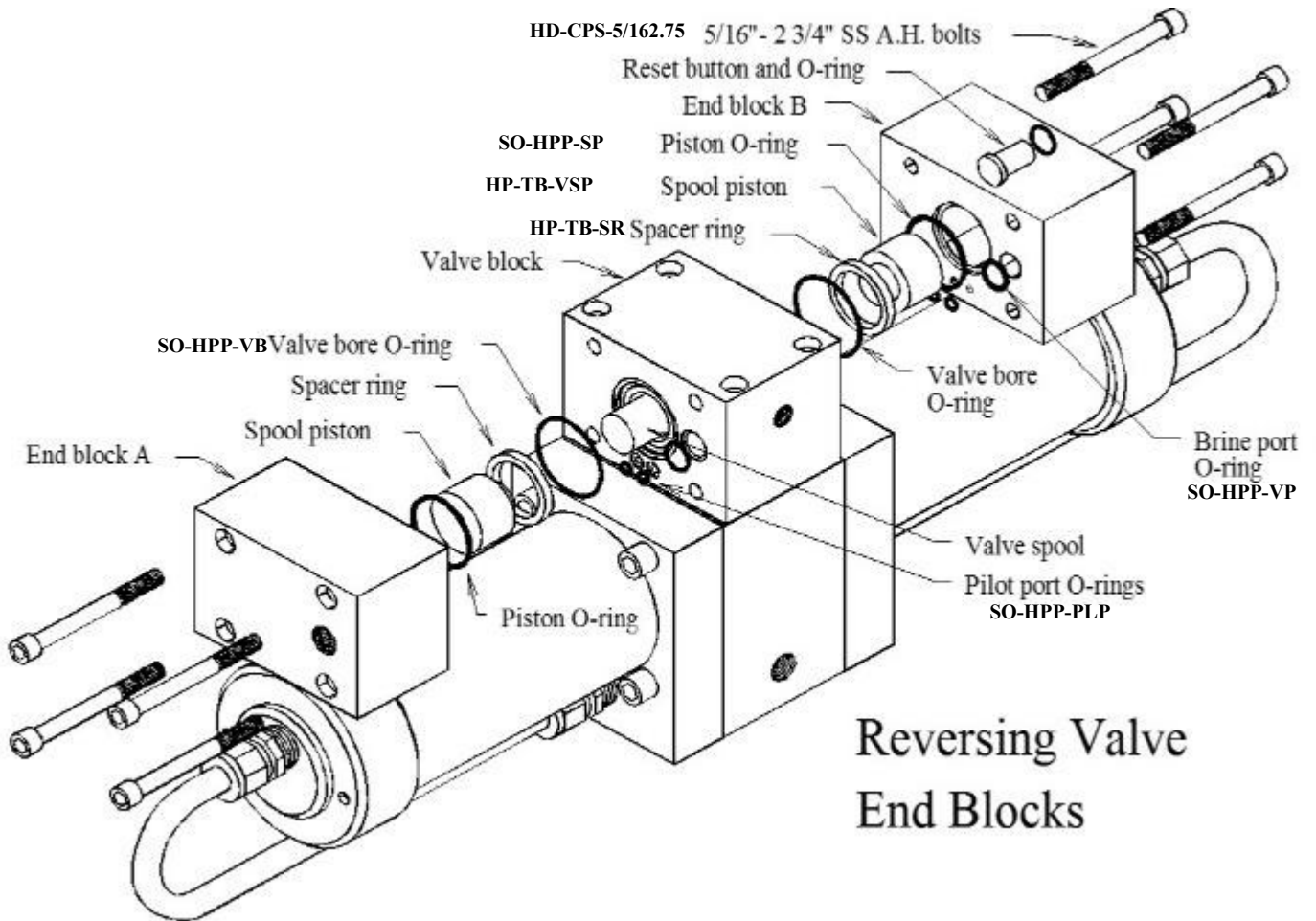

Reversing Valve
End Blocks

Parts

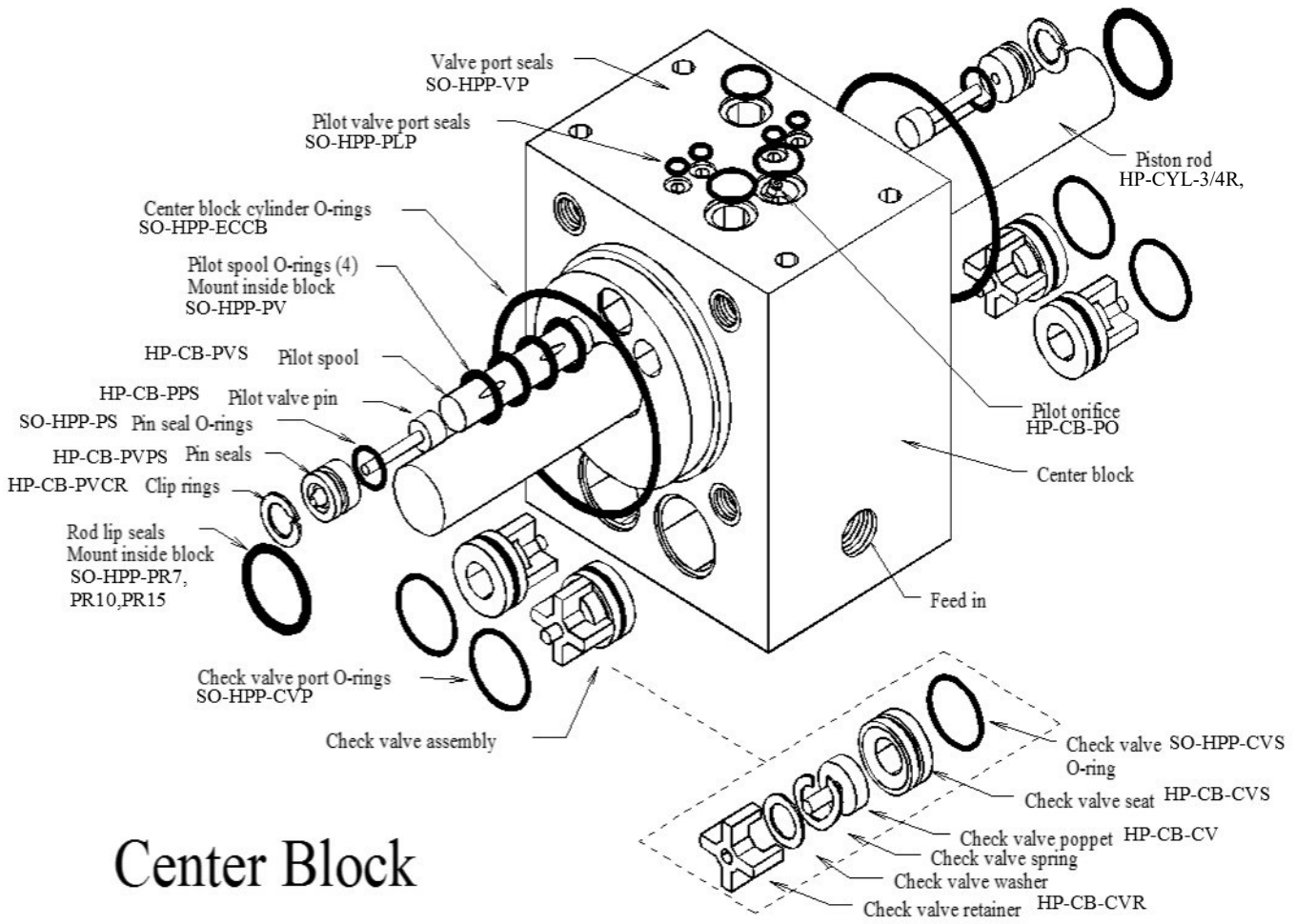

Center Block

Clark Pump Cylinder Assembly

